



PRODUCT DATA 2023

UNILOCK®

Calculate

paver and
wall projects
FASTER!

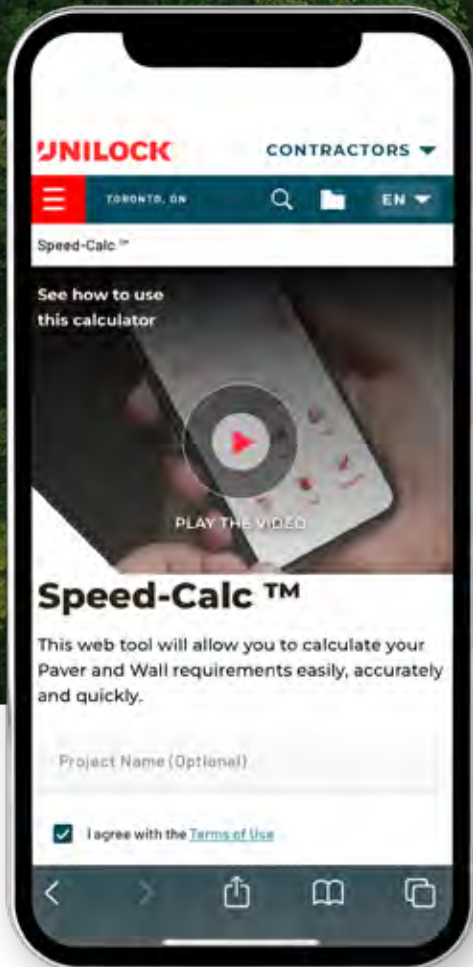

Email
directly
to your
Unilock
Dealer



Try **SPEED-CALC**™
by **UNILOCK**®



TABLE OF CONTENTS - CHICAGO

PAVERS

ADA Paver	4
Anchorlock™	5
Arcana™	6
Artline™ Smooth	7
Artline™ Umbriano®	8
Artline™ Il Campo®	9
Beacon Hill™ Flagstone	10
Beacon Hill™ Smooth	12
Bristol Valley®	14
Brussels Block®	16
Copthorne®	17
Courtstone®	18
Eco-Line®	19
Eco-Optiloc™	20
Eco-Priora™	21
Eco-Promenade®	22
Hex Paver™	23
Hollandstone™	24
Holland Premier™	26
Mattoni™	27
Natural Stone - Sandstone	28
Natural Stone - Limestone	30
Nordic Cobble™	32
Optiloc®	33
Porcelain	34
Promenade™ Plank Paver	37
Richcliff®	39
Series™	40
Skyline™	42
Soreno™	43
Town Hall®	44
Treo® Smooth	45
Tribeca Cobble™	46
Turfstone™	47
Umbriano™	48
Westport™	50

More laying patterns available at unilock.com

RETAINING WALLS, COPING, STEPS & PILLAR CAPS

Brussels Dimensional Stone®	51
DuraHold®	52
Estate Wall™	53
Lineo™ Dimensional Stone	54
Olde Quarry™	55
Olde Quarry™ Smooth NEW	56
Pisa™	57
Pisa XL Smooth™ NEW	58
SienaEdge™	59
SienaStone™	60
SienaStone™ Smooth Step	61
U-Cara®	62
U-Cara® Modular System	66
U-Cara® Wall Mount System	67
Universal Coping & U-Grip™ Base	68
Ledgestone™	69
Brussels Fullnose™ NEW	71
6x12 Fullnose NEW	72
Architectural Coping	73
Umbriano® Coping NEW	74

FIRE FEATURES

Sunset Firepit	75
Unilock Elements	76

ACCESSORIES

Paver Cleaners	78
Adhesives	78
Paver Sealers	79
Sands	79
Permeable Chip Products	80
Geotextiles and Fabric Products	80
Gator Base System	81
Edging & Stainless FP Insert	82
Unilock Pedestal System	83

PRODUCT & INSTALLATION INFORMATION

Sealer & Polysand Best Practices	84
Terms & Conditions	85
Freight Rates & Important Notes	86
Product Directory	90

DESCRIPTION OF EDGE DETAILS

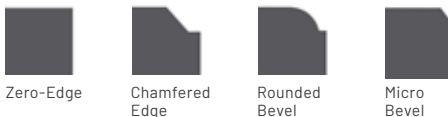

Zero-Edge Chamfered Edge Rounded Bevel Micro Bevel

APPLICATION INDEX

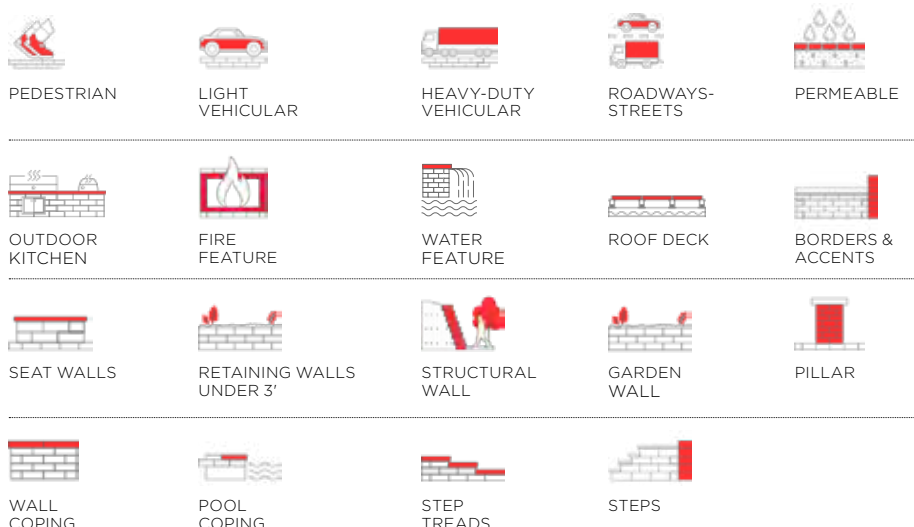



APPLICATIONS



APPEARANCE

Edge Detail - Chamfer
 Surface Texture - Smooth
 Joint Spacing - 3 mm

TECHNOLOGIES

CLASSIC
 Budget-friendly traditional product mix

DRIVE FRIENDLY

Can handle vehicular loads

TECHNICAL INFORMATION

Conforms to ASTM C936
 Eligible for LEED v4.1 credits

	12 X 12
Bundle Type	SINGLE
Plant Produced	CHICAGO
Thickness (mm)	70 MM

SQFT PER	Bundle	93.04
	Layer	11.63
	Section	-
	Stone	0.97

PER BUNDLE	Layers	8.00
	Sections	-

SOLDIER LNFT PER	SqFt	1.02
	Section	-
	Layer	11.81
	Bundle	94.49

SAILOR LNFT PER	SqFt	1.02
	Section	-
	Layer	11.81
	Bundle	94.49

UNITS PER	SqFt	1.03
	Section	-
	Bundle	96.00

LBS PER	Layer	389
	Section	-
	Bundle	3,114

COLORS	Reflectance	Stock
Charcoal	SR n/a SRI n/a	SO
Red	SR n/a SRI n/a	SO

Single Unit



STANDARD
 300 x 300 x 70mm
 11 7/8 x 11 7/8 x 2 3/4
 96 units/Bundle
 .97 Sq.Ft./Stone

Notes: **Special Order - Lead time required.** Minimum quantities apply. **SOLD IN FULL BUNDLES ONLY.** All measurements are nominal. Contact Unilock for more information.



APPLICATIONS



APPEARANCE

Edge Detail - Chamfer
 Surface Texture - Smooth
 Joint Spacing - 3 mm

TECHNOLOGIES

CLASSIC

Budget-friendly traditional product mix

DRIVE FRIENDLY

Can handle vehicular loads

TECHNICAL INFORMATION

Conforms to ASTM C936
 Eligible for LEED v4.1 credits

	8 7/8 X 8 7/8
Bundle Type	SINGLE
Plant Produced	CHICAGO
Thickness (mm)	80 MM

SQFT PER	Bundle	86.72
	Layer	10.84
	Section	-
	Stone	0.41

PER BUNDLE	Layers	8.00
	Sections	-

SOLDIER LNFT PER	SqFt	-
	Section	-
	Layer	-
	Bundle	-

SAILOR LNFT PER	SqFt	-
	Section	-
	Layer	-
	Bundle	-

UNITS PER	SqFt	2.46
	Section	-
	Bundle	213.36

LBS PER	Layer	374
	Section	-
	Bundle	2,991

COLORS	Reflectance	Stock
Natural	SR .30 SRI 32	SO

LAYING PATTERN

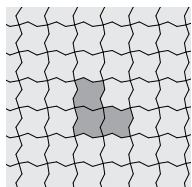

Anchorlock A

Single Unit



STANDARD
 225 x 225 x 80mm
 8 7/8 x 8 7/8 x 3 1/8
 213.36 units/Bundle
 .41 Sq.Ft./Stone

Notes: **Special Order - Lead time required.** Minimum quantities apply. **SOLD IN FULL BUNDLES ONLY.** 1/3 stones incorporated in each bundle; 16 pieces per bundle. The 1/3 stone is not shown. Product is optimized for mechanical installation. All measurements are nominal. Contact Unilock for more information.



APPLICATIONS



APPEARANCE

Edge Detail - Micro
Surface Texture - Smooth
Joint Spacing - 0 mm

TECHNOLOGIES

ENDURACOLOR™
Refined surface and long-lasting color

EASYCLEAN™

Factory sealed to provide integral stain resistance

TECHNICAL INFORMATION

Conforms to ASTM C 1782
Eligible for LEED v4.1 credits

	12 X 24	18 X 24	24 X 24
Bundle Type	SINGLE	SINGLE	SINGLE
Plant Produced	CHICAGO	CHICAGO	CHICAGO
Thickness (mm)	50 MM	50 MM	50 MM

SQFT PER	Bundle	36.00	54.00	72.00
	Layer	4.00	6.00	8.00
	Section	-	-	-
	Stone	2.00	3.00	4.00

PER BUNDLE	Layers	9.00	9.00	9.00
	Sections	-	-	-

SOLDIER LNFT PER	SqFt	0.49	0.50	0.50
	Section	-	-	-
	Layer	1.98	2.97	3.98
	Bundle	17.78	26.75	35.79

SAILOR LNFT PER	SqFt	0.99	0.66	0.50
	Section	-	-	-
	Layer	3.98	3.98	3.98
	Bundle	35.79	35.79	35.79

UNITS PER	SqFt	0.50	0.33	0.25
	Section	-	-	-
	Bundle	18.00	18.00	18.00

LBS PER	Layer	96	144	192
	Section	-	-	-
	Bundle	864	1,296	1,728

COLORS	Reflectance	Stock	Stock	Stock
Corvara	SR n/a SRI n/a	✓	✓	✓
Avorio	SR .56 SRI 66	✓	✓	✓
Modena	SR n/a SRI n/a	✓	✓	✓
Vivanto	SR n/a SRI n/a	✓	✓	✓

LAYING PATTERNS

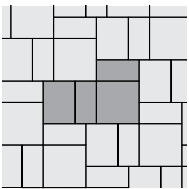

Arcana Random A

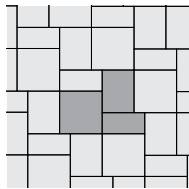

Arcana Random C

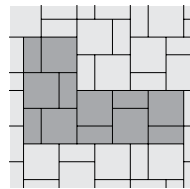

Arcana Random F

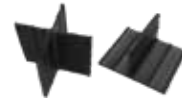

X & T Slab Spacers
Bagged Separately
(see page 80)

Single Units	12 X 24	18 X 24	24 X 24
	301 x 606 x 50mm 11 ⁷ / ₈ x 23 ⁷ / ₈ x 2" 18 units/Bundle 2 Sq.Ft./Stone	453 x 606 x 50mm 17 ⁷ / ₈ x 23 ⁷ / ₈ x 2" 18 units/Bundle 3 Sq.Ft./Stone	606 x 606 x 50mm 23 ⁷ / ₈ x 23 ⁷ / ₈ x 2" 18 units/Bundle 4 Sq.Ft./Stone

Notes: **SOLD IN FULL BUNDLES ONLY** and is produced and sold on a required, refundable skid. **This product is not intended for vehicular applications. Important: A urethane rubber paver mat must be used to prevent scuffing when compacting.** All measurements are nominal. Unilock recommends installing Arcana using X & T Slab Spacers. Please see page 80. Contact Unilock for more information.



APPLICATIONS



APPEARANCE

Edge Detail - Micro
 Surface Texture - Smooth
 Joint Spacing - 3 mm

TECHNOLOGIES

ENDURACOLOR™
 Refined surface and long-lasting color

EASYCLEAN™

Factory sealed to provide integral stain resistance

COMFORT STEP

Ultra smooth surface texture

TECHNICAL INFORMATION

Conforms to ASTM C 936
 Eligible for LEED v4.1 credits

		SMOOTH FINISH
	Bundle Type	RANDOM
	Plant Produced	MARENGO
	Thickness (mm)	70 MM

SQFT PER	Bundle	93.25
	Layer	11.66
	Section	-
	Stone	-

PER BUNDLE	Layers	8.00
	Sections	-

SOLDIER LNFT PER	SqFt	-
	Section	-
	Layer	-
	Bundle	-

SAILOR LNFT PER	SqFt	-
	Section	-
	Layer	-
	Bundle	-

UNITS PER	SqFt	-
	Section	-
	Bundle	192.00

LBS PER	Layer	370
	Section	-
	Bundle	2,963

COLORS	Reflectance	Stock
Bavarian Blend	SR n/a SRI n/a	✓
Fossil	SR n/a SRI n/a	✓
Steel Mountain	SR n/a SRI n/a	✓

LAYING PATTERN

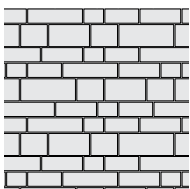

Artline Random A

7 Unit Random Bundle



UNIT A
 125 x 169 x 70mm
 4 7/8 x 6 3/4 x 2 3/4"
 32 units/Bundle
 .23 Sq.Ft./Stone



UNIT B
 125 x 262.5 x 70mm
 4 7/8 x 10 3/8 x 2 3/4"
 32 units/Bundle
 .35 Sq.Ft./Stone

7 Unit Random Bundle



UNIT C
 125 x 337.5 x 70mm
 4 7/8 x 13 3/8 x 2 3/4"
 32 units/Bundle
 .45 Sq.Ft./Stone



UNIT D
 125 x 450 x 70mm
 4 7/8 x 17 3/4 x 2 3/4"
 32 units/Bundle
 .61 Sq.Ft./Stone



UNIT E
 187.5 x 225 x 70mm
 7 1/2 x 8 7/8 x 2 3/4"
 32 units/Bundle
 .45 Sq.Ft./Stone



UNIT F
 187.5 x 337.5 x 70mm
 7 1/2 x 13 3/8 x 2 3/4"
 16 units/Bundle
 .69 Sq.Ft./Stone



UNIT G
 187.5 x 450 x 70mm
 7 1/2 x 17 3/4 x 2 3/4"
 16 units/Bundle
 .91 Sq.Ft./Stone

Notes: **SOLD IN FULL BUNDLES ONLY** and is produced and sold on a required, refundable skid. **Important:** A urethane rubber paver mat must be used to prevent scuffing when compacting. All measurements are nominal. Contact Unilock for more information.



APPLICATIONS



APPEARANCE

Edge Detail - Micro
 Surface Texture - Umbriano Mottled
 Joint Spacing - 3 mm

TECHNOLOGIES

ENDURACOLOR™
 Refined surface and long-lasting color

EASYSOAK™

Factory sealed to provide integral stain resistance

COLORFUSION™

Subtly mottled colored finish

TECHNICAL INFORMATION

Conforms to ASTM C 936
 Eligible for LEED v4.1 credits

	UMBRIANO FINISH
Bundle Type	RANDOM
Plant Produced	MARENGO
Thickness (mm)	70 MM

SQFT PER	Bundle	93.25
	Layer	11.66
	Section	-
	Stone	-

PER BUNDLE	Layers	8.00
	Sections	-

SOLDIER LNFT PER	SqFt	-
	Section	-
	Layer	-
	Bundle	-

SAILOR LNFT PER	SqFt	-
	Section	-
	Layer	-
	Bundle	-

UNITS PER	SqFt	-
	Section	-
	Bundle	192.00

LBS PER	Layer	373
	Section	-
	Bundle	2,986

COLORS	Reflectance	Stock
French Grey	SR .18 SRI 17	✓
Midnight Sky	SR .17 SRI 15	✓
Winter Marvel	SR .35 SRI 38	✓

LAYING PATTERN

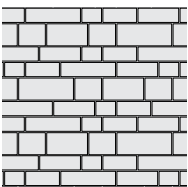

Artline Random A

7 Unit Random Bundle



UNIT A
 125 x 169 x 70mm
 4 7/8 x 6 3/4 x 2 3/4"
 32 units/Bundle
 .23 Sq.Ft./Stone



UNIT B
 125 x 262.5 x 70mm
 4 7/8 x 10 3/8 x 2 3/4"
 32 units/Bundle
 .35 Sq.Ft./Stone

7 Unit Random Bundle



UNIT C
 125 x 337.5 x 70mm
 4 7/8 x 13 3/8 x 2 3/4"
 32 units/Bundle
 .45 Sq.Ft./Stone



UNIT D
 125 x 450 x 70mm
 4 7/8 x 17 3/4 x 2 3/4"
 32 units/Bundle
 .61 Sq.Ft./Stone



UNIT E
 187.5 x 225 x 70mm
 7 1/2 x 8 7/8 x 2 3/4"
 32 units/Bundle
 .45 Sq.Ft./Stone



UNIT F
 187.5 x 337.5 x 70mm
 7 1/2 x 13 3/8 x 2 3/4"
 16 units/Bundle
 .69 Sq.Ft./Stone



UNIT G
 187.5 x 450 x 70mm
 7 1/2 x 17 3/4 x 2 3/4"
 16 units/Bundle
 .91 Sq.Ft./Stone

Notes: **SOLD IN FULL BUNDLES ONLY** and is produced and sold on a required, refundable skid. **Important:** A urethane rubber paver mat must be used to prevent scuffing when compacting. All measurements are nominal. Contact Unilock for more information.



APPLICATIONS



APPEARANCE

Edge Detail - Micro
Surface Texture - Il Campo
Joint Spacing - 3 mm

TECHNOLOGIES

ENDURACOLOR™
Refined surface and long-lasting color

TECHNICAL INFORMATION

Conforms to ASTM C 936
Eligible for LEED v4.1 credits

	IL CAMPO FINISH
Bundle Type	RANDOM
Plant Produced	CHICAGO
Thickness (mm)	70 MM

SQFT PER	Bundle	93.25
	Layer	11.66
	Section	-
	Stone	-

PER BUNDLE	Layers	8.00
	Sections	-

SOLDIER LNFT PER	SqFt	-
	Section	-
	Layer	-
	Bundle	-

SAILOR LNFT PER	SqFt	-
	Section	-
	Layer	-
	Bundle	-

UNITS PER	SqFt	-
	Section	-
	Bundle	192.00

LBS PER	Layer	370
	Section	-
	Bundle	2,963

COLORS	Reflectance	Stock
Bavarian Blend	SR n/a SRI n/a	✓
Granite Blend	SR n/a SRI n/a	✓

LAYING PATTERN

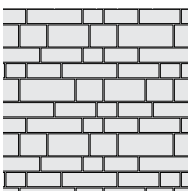

Artline Random A

7 Unit Random Bundle					
	UNIT C 125 x 337.5 x 70mm 4 7/8 x 13 3/8 x 2 3/4" 32 units/Bundle .45 Sq.Ft./Stone	UNIT D 125 x 450 x 70mm 4 7/8 x 17 3/4 x 2 3/4" 32 units/Bundle .61 Sq.Ft./Stone	UNIT E 187.5 x 225 x 70mm 7 1/2 x 8 7/8 x 2 3/4" 32 units/Bundle .45 Sq.Ft./Stone	UNIT F 187.5 x 337.5 x 70mm 7 1/2 x 13 3/8 x 2 3/4" 16 units/Bundle .69 Sq.Ft./Stone	UNIT B 125 x 262.5 x 70mm 4 7/8 x 10 3/8 x 2 3/4" 32 units/Bundle .35 Sq.Ft./Stone

Notes: **SOLD IN FULL BUNDLES ONLY** and is produced and sold on a required, refundable skid. **Important: A urethane rubber paver mat must be used to prevent scuffing when compacting.** All measurements are nominal. Contact Unilock for more information.

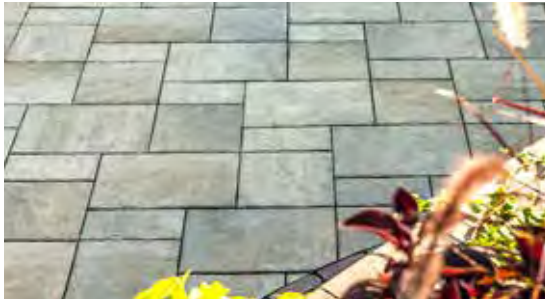

APPLICATIONS



APPEARANCE

Edge Detail - Rounded
 Surface Texture - Textured
 Joint Spacing - 3 mm

TECHNOLOGIES

ENDURACOLOR™
 Refined surface and long-lasting color

TECHNICAL INFORMATION

Conforms to ASTM C 936
 Eligible for LEED v4.1 credits

LAYING PATTERNS

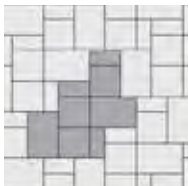

BeaconHill Fixed Random A

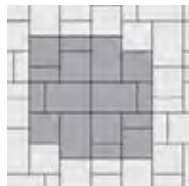

BeaconHill Fixed Random B

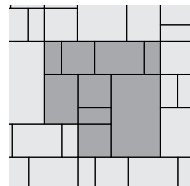

BeaconHill Multi-Unit Random C

		XL UNIT
Bundle Type	RANDOM	SINGLE
Plant Produced	MARENGO	MARENGO
Thickness (mm)	60 MM	60 MM

SQFT PER	Bundle	116.57	116.57
	Layer	11.66	11.66
	Section	-	-
	Stone	-	5.83

PER BUNDLE	Layers	10.00	10.00
	Sections	-	-

SOLDIER LNFT PER	SqFt	-	0.32
	Section	-	-
	Layer	-	3.74
	Bundle	-	37.40

SAILOR LNFT PER	SqFt	0.80	0.53
	Section	-	-
	Layer	9.35	6.23
	Bundle	93.50	62.30

UNITS PER	SqFt	-	0.17
	Section	-	-
	Bundle	80.00	20.00

LBS PER	Layer	322	324
	Section	-	-
	Bundle	3,221	3,241

COLORS	Reflectance	Stock	Stock
Alpine Grey	SR n/a SRI n/a	✓	✓
Bavarian	SR n/a SRI n/a	✓	✓
Fossil	SR n/a SRI n/a	✓	✓
Walnut NEW	SR n/a SRI n/a	✓	-

3 Unit Random Bundle				Single Unit	
	LARGE RECTANGLE 380 x 570 x 60mm 15 x 22 1/2 x 2 3/8" 20 Units/Bundle 2.08 SqFt/Stone	SQUARE 380 x 380 x 60mm 15 x 15 x 2 3/8" 30 units/Bundle 1.39 Sq.Ft./Stone	SMALL RECTANGLE 380 x 190 x 60mm 15 x 7 1/2 x 2 3/8" 30 units/Bundle .69 Sq.Ft./Stone		XL UNIT 950 x 570 x 60mm 37 1/2 x 22 1/2 x 2 3/8" 20 units/Bundle 5.83 Sq.Ft./Stone

Notes: **SOLD IN FULL BUNDLES ONLY** and is produced and sold on a required, refundable skid. **This product is not intended for vehicular applications. Important: A urethane rubber paver mat must be used to prevent scuffing when compacting.** All measurements are nominal. Contact Unilock for more information.



APPLICATIONS



APPEARANCE

Edge Detail - Rounded
 Surface Texture - Textured
 Joint Spacing - 3 mm

TECHNOLOGIES

ENDURACOLOR™
 Refined surface and long-lasting color

TECHNICAL INFORMATION

Conforms to ASTM C 936
 Eligible for LEED v4.1 credits

Bundle Type	RANDOM - OLD SIZES	RANDOM - NEW SIZES
Plant Produced	MARENGO	MARENGO
Thickness (mm)	80 MM	80 MM

SQFT PER	Bundle	73.22	81.60
	Layer	10.46	11.66
	Section	-	-
	Stone	-	-

PER BUNDLE	Layers	7.00	7.00
	Sections	-	-

SOLDIER LNFT PER	SqFt	-	-
	Section	-	-
	Layer	-	-
	Bundle	-	-

SAILOR LNFT PER	SqFt	0.85	0.80
	Section	-	-
	Layer	8.86	9.35
	Bundle	62.00	65.45

UNITS PER	SqFt	-	-
	Section	-	-
	Bundle	56.00	56.00

LBS PER	Layer	384	426
	Section	-	-
	Bundle	2,686	2,979

COLORS	Reflectance	Stock	Stock
Bavarian	SR n/a SRI n/a	SO	✓
Fossil	SR n/a SRI n/a	SO	✓
Walnut NEW	SR n/a SRI n/a	-	✓

LAYING PATTERNS

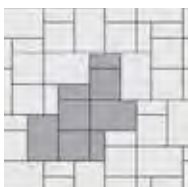

BeaconHill Fixed
Random A

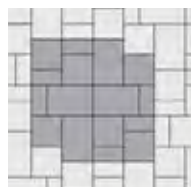

BeaconHill Fixed
Random B

NEW SIZES

3 Unit Random Bundle



LARGE RECTANGLE
 380 x 570 x 80mm
 15 x 22 1/2 x 3 1/8"
 14 Units/Bundle
 2.08 SqFt./Stone



SQUARE
 380 x 380 x 80mm
 15 x 15 x 3 1/8"
 21 units/Bundle
 1.39 Sq.Ft./Stone



SMALL RECTANGLE
 380 x 190 x 80mm
 15 x 7 1/2 x 3 1/8"
 21 units/Bundle
 .69 Sq.Ft./Stone

Notes: **SOLD IN FULL BUNDLES ONLY** and is produced and sold on a required, refundable skid. **Important:** A urethane rubber paver mat must be used to prevent scuffing when compacting. All measurements are nominal. Contact Unilock for more information.



APPLICATIONS



APPEARANCE

Edge Detail - Rounded
Surface Texture - Smooth
Joint Spacing - 3 mm

TECHNOLOGIES

ENDURACOLOR™

Refined surface and long-lasting color

EASYCLEAN™ (Select Colors)

Factory sealed to provide integral stain resistance

TECHNICAL INFORMATION

Conforms to ASTM C 936
Eligible for LEED v4.1 credits

LAYING PATTERNS



BeaconHill Fixed
Random A

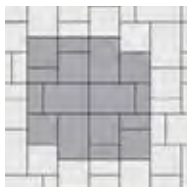

BeaconHill Fixed
Random B

		SMALL RECTANGLE	XL UNIT
Bundle Type	RANDOM	SINGLE	SINGLE
Plant Produced	MARENGO	MARENGO	MARENGO
Thickness (mm)	60 MM	60 MM	60 MM

SQFT PER	Bundle	116.57	116.57	116.57
	Layer	11.66	11.66	11.66
	Section	-	-	-
	Stone	-	0.78	5.83

PER BUNDLE	Layers	10.00	10.00	10.00
	Sections	-	-	-





SOLDIER LNFT PER	SqFt	-	0.80	0.32
	Section	-	-	-
	Layer	-	9.35	3.74
	Bundle	-	93.50	37.40

SAILOR LNFT PER	SqFt	0.80	1.60	0.53
	Section	-	-	-
	Layer	9.35	18.70	6.23
	Bundle	93.50	187.01	62.30

UNITS PER	SqFt	-	1.29	0.17
	Section	-	-	-
	Bundle	80.00	150.00	20.00

LBS PER	Layer	322	320	325
	Section	-	-	-
	Bundle	3,216	3,199	3,249

COLORS	Reflectance	Stock	Stock	Stock
Bavarian	SR n/a SRI n/a	✓	✓	✓
Champagne (EC) NEW	SR n/a SRI n/a	✓	✓	SO
Dark Charcoal NEW	SR n/a SRI n/a	-	✓	-
Fossil	SR .22 SRI 21	✓	-	✓
Granite Fusion	SR .28 SRI 29	✓	✓	✓
Opal Blend (EC) NEW	SR n/a SRI n/a	✓	-	SO

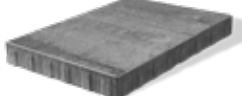
3 Unit Random Bundle				Single Unit		
	LARGE RECTANGLE 380 x 570 x 60mm 15 x 22 1/2 x 2 3/8" 20 Units/Bundle 2.08 SqFt/Stone	SQUARE 380 x 380 x 60mm 15 x 15 x 2 3/8" 30 units/Bundle 1.39 Sq.Ft./Stone	SMALL RECTANGLE 380 x 190 x 60mm 15 x 7 1/2 x 2 3/8" 30 units/Bundle .69 Sq.Ft./Stone		SMALL RECTANGLE 380 X 190 X 60MM 15 X 7 1/2 X 2 3/8" 150 Units/Bundle .78 Sq.Ft./Stone	XL UNIT 950 x 570 x 60mm 37 1/2 x 22 1/2 x 2 3/8" 20 units/Bundle 5.83 Sq.Ft./Stone

Notes: **SOLD IN FULL BUNDLES ONLY** and is produced and sold on a required, refundable skid. **This product is not intended for vehicular applications. Important: A urethane rubber paver mat must be used to prevent scuffing when compacting.** All measurements are nominal. Contact Unilock for more information.



APPLICATIONS



APPEARANCE

Edge Detail - Rounded
 Surface Texture - Textured
 Joint Spacing - 3 mm

TECHNOLOGIES

ENDURACOLOR™
 Refined surface and long-lasting color

EASYSOAK™

Factory sealed to provide integral stain resistance

TECHNICAL INFORMATION

Conforms to ASTM C 936
 Eligible for LEED v4.1 credits

LAYING PATTERNS



Beacon Hill Fixed
 Random A

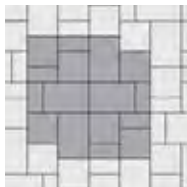

Beacon Hill Fixed
 Random B

Bundle Type	RANDOM
Plant Produced	MARENGO
Thickness (mm)	80 MM

SQFT PER	Bundle	81.60
	Layer	11.66
	Section	-
	Stone	-

PER BUNDLE	Layers	7.00
	Sections	-

SOLDIER LNFT PER	SqFt	-
	Section	-
	Layer	-
	Bundle	-

SAILOR LNFT PER	SqFt	0.80
	Section	-
	Layer	9.35
	Bundle	65.45

UNITS PER	SqFt	-
	Section	-
	Bundle	56.00

LBS PER	Layer	426
	Section	-
	Bundle	2,982

COLORS	Reflectance	Stock
Bavarian	SR .22 SRI 21	✓
Fossil	SR .28 SRI 29	SO
Granite Fusion	SR .28 SRI 29	✓
Opal Blend	SR .28 SRI 29	SO

3 Unit Random Bundle



LARGE RECTANGLE
 380 x 570 x 80mm
 15 x 22 1/2 x 3 1/8"
 14 Units/Bundle
 2.08 SqFt/Stone



SQUARE
 380 x 380 x 80mm
 15 x 15 x 3 1/8"
 21 units/Bundle
 1.39 Sq.Ft./Stone



SMALL RECTANGLE
 380 x 190 x 80mm
 15 x 7 1/2 x 3 1/8"
 21 units/Bundle
 .69 Sq.Ft./Stone

Notes: **SOLD IN FULL BUNDLES ONLY** and is produced and sold on a required, refundable skid. **Important:** A urethane rubber paver mat must be used to prevent scuffing when compacting. All measurements are nominal. Contact Unilock for more information.



APPLICATIONS



APPEARANCE

Edge Detail - Zero
 Surface Texture - Textured
 Joint Spacing - 3 mm

TECHNOLOGIES

ENDURACOLOR™
 Refined surface and long-lasting color

EASYSOFT™

Factory sealed to provide integral stain resistance

COMFORT STEP™

Ultra smooth surface texture

TECHNICAL INFORMATION

Conforms to ASTM C 936
 Eligible for LEED v4.1 credits

LAYING PATTERNS

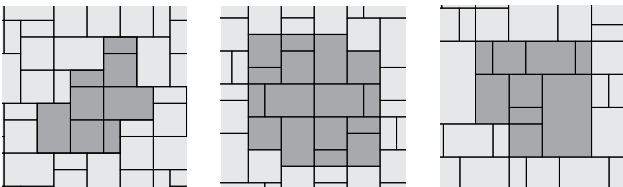

Bristol Valley Random A Bristol Valley Random B Bristol Valley Multi-Unit Random C

		XL UNIT
Bundle Type	RANDOM	SINGLE
Plant Produced	MARENGO	MARENGO
Thickness (mm)	60 MM	60 MM

SQFT PER	Bundle	116.57	116.57
	Layer	11.66	11.66
	Section	-	-
	Stone	-	5.83

PER BUNDLE	Layers	10.00	10.00
	Sections	-	-

SOLDIER LNFT PER	SqFt	-	0.32
	Section	-	-
	Layer	-	3.74
	Bundle	-	37.40

SAILOR LNFT PER	SqFt	0.80	0.53
	Section	-	-
	Layer	9.35	6.23
	Bundle	93.50	62.30

UNITS PER	SqFt	-	0.17
	Section	-	-
	Bundle	80.00	20.00

LBS PER	Layer	330	321
	Section	-	-
	Bundle	3,302	3,210

COLORS	Reflectance	Stock	Stock
Bavarian	SR n/a SRI n/a	✓	✓
Fossil	SR n/a SRI n/a	✓	✓
Steel Mountain	SR n/a SRI n/a	✓	✓
Walnut NEW	SR n/a SRI n/a	✓	-

3 Unit Random Bundle				Single Unit	
	LARGE RECTANGLE 380 x 570 x 60mm 15 x 22 1/2 x 2 3/8" 20 Units/Bundle 2.08 SqFt/Stone	SQUARE 380 x 380 x 60mm 15 x 15 x 2 3/8" 30 units/Bundle 1.39 Sq.Ft./Stone	SMALL RECTANGLE 380 x 190 x 60mm 15 x 7 1/2 x 2 3/8" 30 units/Bundle .69 Sq.Ft./Stone		XL UNIT 950 x 570 x 60mm 37 1/2 x 22 1/2 x 2 3/8" 20 units/Bundle 5.83 Sq.Ft./Stone

Notes: **SOLD IN FULL BUNDLES ONLY** and is produced and sold on a required, refundable skid. **This product is not intended for vehicular applications. Important: A urethane rubber paver mat must be used to prevent scuffing when compacting.** All measurements are nominal. Contact Unilock for more information.



APPLICATIONS



APPEARANCE

Edge Detail - Zero
 Surface Texture - Textured
 Joint Spacing - 3 mm

TECHNOLOGIES

ENDURACOLOR™
 Refined surface and long-lasting color

EASYSOFT™

Factory sealed to provide integral stain resistance

COMFORT STEP

Ultra smooth surface texture

TECHNICAL INFORMATION

Conforms to ASTM C 936
 Eligible for LEED v4.1 credits

LAYING PATTERNS

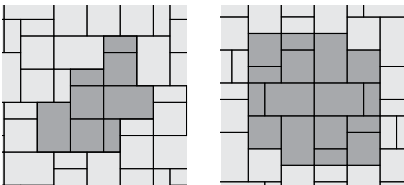

Bristol Valley Random A Bristol Valley Random B

	Bundle Type	RANDOM
	Plant Produced	MARENGO
	Thickness (mm)	80 MM

SQFT PER	Bundle	81.60
	Layer	11.66
	Section	-
	Stone	-

PER BUNDLE	Layers	7.00
	Sections	-

SOLDIER LNFT PER	SqFt	-
	Section	-
	Layer	-
	Bundle	-

SAILOR LNFT PER	SqFt	0.80
	Section	-
	Layer	9.35
	Bundle	65.45

UNITS PER	SqFt	-
	Section	-
	Bundle	56.00

LBS PER	Layer	418
	Section	-
	Bundle	2,925

COLORS	Reflectance	Stock
Bavarian	SR n/a SRI n/a	✓
Fossil	SR n/a SRI n/a	SO
Steel Mountain	SR n/a SRI n/a	✓

3 Unit Random Bundle			
	LARGE RECTANGLE	SQUARE	SMALL RECTANGLE
	380 x 570 x 80mm 15 x 22 1/2 x 3 1/8"	380 x 380 x 80mm 15 x 15 x 3 1/8"	380 x 190 x 80mm 15 x 7 1/2 x 3 1/8"
	14 Units/Bundle 2.08 SqFt./Stone	21 units/Bundle 1.39 Sq.Ft./Stone	21 units/Bundle 69 Sq.Ft./Stone

Notes: **SOLD IN FULL BUNDLES ONLY** and is produced and sold on a required, refundable skid. **Important:** A urethane rubber paver mat must be used to prevent scuffing when compacting. All measurements are nominal. Contact Unilock for more information.



APPLICATIONS



APPEARANCE

Edge Detail - Zero
 Surface Texture - Weathered
 Joint Spacing - 2 mm

TECHNOLOGIES

CLASSIC
 Budget-friendly traditional product mix

ANTIQUED™

Distressed, timeworn finish

TECHNICAL INFORMATION

Conforms to ASTM C 936
 Eligible for LEED v4.1 credits

LAYING PATTERNS

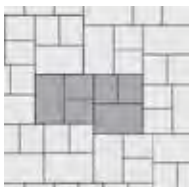

Brussels Multi-Unit
Random AC



Brussels Multi-Unit
Random AD



Brussels Multi-Unit
Random AE

	HALF	STANDARD	XL
Bundle Type	SINGLE	SINGLE	SINGLE
Plant Produced	ELKHORN / CHICAGO		
Thickness (mm)	70 MM	70 MM	70 MM

SQFT PER	Bundle	88.70	94.91	95.70
	Layer	11.09	11.86	9.57
	Section	12.67	15.82	31.90
	Stone	0.20	0.40	0.80

PER BUNDLE	Layers	8.00	8.00	10.00
	Sections	7.00	6.00	3.00

SOLDIER LNFT PER	SqFt	1.72	1.44	0.86
	Section	21.84	22.70	27.30
	Layer	19.11	17.03	8.19
	Bundle	152.86	136.22	81.89

SAILOR LNFT PER	SqFt	2.87	1.73	1.43
	Section	36.33	27.30	45.67
	Layer	31.78	20.47	13.70
	Bundle	254.28	163.78	137.01

UNITS PER	SqFt	5.05	2.53	1.25
	Section	64.00	40.00	40.00
	Bundle	448.00	240.00	120.00

LBS PER	Layer	358	389	311
	Section	409	518	1,037
	Bundle	2,865	3,110	3,112

COLORS	Reflectance	Stock	Stock	Stock
Limestone	SR .28 SRI 29	✓	✓	✓
River	SR n/a SRI n/a	✓	✓	✓
Sandstone	SR .41 SRI 46	✓	✓	✓
Sierra	SR n/a SRI n/a	✓	✓	✓

Single Units



HALF
 104 x 173 x 70mm
 4 x 6 7/8 x 2 3/4"
 448 units/Bundle
 .20 Sq.Ft./Stone



STANDARD
 173 x 208 x 70mm
 6 7/8 x 8 1/4 x 2 3/4"
 240 units/Bundle
 .40 Sq.Ft./Stone



XL
 208 x 348 x 70mm
 8 1/4 x 13 3/4 x 2 3/4"
 120 units/Bundle
 .80 Sq.Ft./Stone

Notes: **Important:** A urethane rubber paver mat must be used to prevent scuffing when compacting. All measurements are nominal. Contact Unilock for more information.



APPLICATIONS



APPEARANCE

Surface Texture - Textured

Joint Spacing - 3 mm

TECHNOLOGIES

ELEGANCE™

Timeless, long-lasting beauty with the combination of Reala and Ultima technologies

REALA™

Cast from historic street pavers

ULTIMA™

Up to 4x stronger than poured-in-place concrete

EASYSOIL™

Factory sealed to provide integral stain resistance

TECHNICAL INFORMATION

Conforms to ASTM C 936

Eligible for LEED v4.1 credits

LAYING PATTERNS

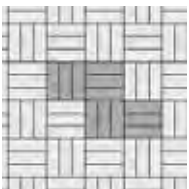

Copthorne BW A

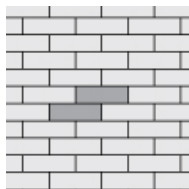

Copthorne RB C

	Bundle Type	SINGLE
	Plant Produced	AYR
	Thickness (mm)	60 MM

SQFT PER	Bundle	89.20
	Layer	11.15
	Section	-
	Stone	0.15

PER BUNDLE	Layers	8.00
	Sections	-

SOLDIER LNFT PER	SqFt	1.43
	Section	-
	Layer	15.99
	Bundle	127.95

SAILOR LNFT PER	SqFt	4.41
	Section	-
	Layer	49.21
	Bundle	393.70

UNITS PER	SqFt	6.73
	Section	-
	Bundle	600.00

LBS PER	Layer	294
	Section	-
	Bundle	2,349

COLORS	Reflectance	Stock
Basalt	SR n/a SRI n/a	✓
Burgundy Red	SR n/a SRI n/a	✓
Burnt Clay	SR n/a SRI n/a	✓
Old Oak	SR n/a SRI n/a	✓

Single Unit



STANDARD

65 x 200 x 60mm
2 5/8" x 7 7/8" x 2 3/8"
600 Units/Bundle
.15 SqFt/Stone

Notes: **SOLD IN FULL BUNDLES ONLY** and is produced and sold on a required, refundable skid. **Important:** A urethane rubber paver mat must be used to prevent scuffing when compacting. All measurements are nominal. Please refer to the Polymeric Sand Best Practices on Page 84. Contact Unilock for more information.



APPLICATIONS



APPEARANCE

Edge Detail - Zero
 Surface Texture - Textured
 Joint Spacing - 15 mm

TECHNOLOGIES

ELEGANCE™

Timeless, long-lasting beauty with the combination of Reala and Ultima technologies

REALA™

Cast from European cobblestones

ULTIMA™

Up to 4x stronger than poured-in-place concrete

EASYCLEAN™

Factory sealed to provide integral stain resistance

TECHNICAL INFORMATION

Conforms to ASTM C 936
 Eligible for LEED v4.1 credits

		Bundle Type	RANDOM
		Plant Produced	AYR
		Thickness (mm)	60 MM
SQFT PER	Bundle		98.30
	Layer		12.29
	Section		-
	Stone		-
PER BUNDLE	Layers		8.00
	Sections		-
SOLDIER LNFT PER	SqFt		-
	Section		-
	Layer		-
	Bundle		-
SAILOR LNFT PER	SqFt		2.25
	Section		-
	Layer		27.69
	Bundle		221.52
UNITS PER	SqFt		-
	Section		-
	Bundle		384.00
LBS PER	Layer		291
	Section		-
	Bundle		2,326
COLORS		Reflectance	Stock
Basalt		SR n/a SRI n/a	✓

LAYING PATTERNS



Courtstone Fixed Random A

5 Unit Random Bundle	XL RECTANGLE	LARGE RECTANGLE	RECTANGLE	SMALL RECTANGLE	SQUARE
	215 x 130 x 60mm 8 1/2 x 5 x 2 3/8"	185 x 130 x 60mm 7 3/8 x 5 x 2 3/8"	165 x 130 x 60mm 6 1/2 x 5 x 2 3/8"	145 x 130 x 60mm 5 x 5 3/4 x 2 3/8"	130 x 130 x 60mm 5 x 5 x 2 3/8"
	128 Units/Bundle .30 SqFt/Stone	64 Units/Bundle .28 SqFt/Stone	64 Units/Bundle .23 SqFt/Stone	64 Units/Bundle .20 SqFt/Stone	64 Units/Bundle .18 SqFt/Stone

Notes: **SOLD IN FULL BUNDLES ONLY** and is produced and sold on a required, refundable skid. **Important:** A urethane rubber paver mat must be used to prevent scuffing when compacting. All measurements are nominal. Please refer to the Polymeric Sand Best Practices on Page 84. Contact Unilock for more information.



LAYING PATTERNS



Ecoline Fixed
Random A

APPLICATIONS



APPEARANCE

Edge Detail - Micro
Surface Texture - Smooth / Umbriano Mottled
Joint Spacing - 6.25 mm
Void - 5.80%

TECHNOLOGIES

PERMEABLE

Can be installed to allow water to flow through

ENDURACOLOR™

Refined surface and long-lasting color

EASYSOFT™  (Umbriano)

Factory sealed to provide integral stain resistance

COLOR FUSION™ (Umbriano)

Subtly mottled color finish

TECHNICAL INFORMATION

Conforms to ASTM C 936
Eligible for LEED v4.1 credits

	ALL FINISHES - See Notes Below	
Bundle Type	RANDOM	
Plant Produced	ELKHORN / CHICAGO	
Thickness (mm)	100 MM	

SQFT PER	Bundle	55.17
	Layer	11.03
	Section	-
	Stone	-

PER BUNDLE	Layers	5.00
	Sections	-

SOLDIER LNFT PER	SqFt	-
	Section	-
	Layer	-
	Bundle	-

SAILOR LNFT PER	SqFt	-
	Section	-
	Layer	-
	Bundle	-

UNITS PER	SqFt	-
	Section	-
	Bundle	160.00

LBS PER	Layer	513
	Section	-
	Bundle	2,564

COLORS	Reflectance	Stock
Custom Colors & Finishes	SR n/a SRI n/a	SO
Please contact your local Sales Representative for color options.		



CLASSIC
Thrumix Finish



IL CAMPO®
Brushed Finish









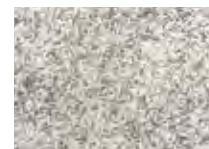

SERIES™
Exposed Granite Finish



SMOOTH
Premier Finish



UMBRIANO®
Mottled Finish with/
ColorFusion and EasyClean

8 Unit Random Bundle								
	UNIT A	UNIT B	UNIT C	UNIT D	UNIT E	UNIT F	UNIT G	UNIT H
	357 x 84 x 100mm	317 x 84 x 100mm	277 x 84 x 100mm	237 x 84 x 100mm	357 x 114 x 100mm	317 x 114 x 100mm	277 x 114 x 100mm	237 x 114 x 100mm
	14 x 3 3/8 x 3 7/8"	12 1/2 x 3 3/8 x 3 7/8"	10 7/8 x 3 3/8 x 3 7/8"	9 3/8 x 3 3/8 x 3 7/8"	14 x 4 1/2 x 3 7/8"	12 1/2 x 4 1/2 x 3 7/8"	10 7/8 x 4 1/2 x 3 7/8"	9 3/8 x 4 1/2 x 3 7/8"
	20 Units/Bundle	20 Units/Bundle	20 Units/Bundle	20 Units/Bundle	20 Units/Bundle	20 Units/Bundle	20 Units/Bundle	20 Units/Bundle
	.32 SqFt/Stone	.29 SqFt/Stone	.25 SqFt/Stone	.21 SqFt/Stone	.44 SqFt/Stone	.39 SqFt/Stone	.34 SqFt/Stone	.29 SqFt/Stone

Notes: **Special Order - Lead time required.** Minimum quantities apply. **SOLD IN FULL BUNDLES ONLY** and is produced and sold on a required, refundable skid. **Important:** A urethane rubber paver mat must be used to prevent scuffing when compacting on textured surfaces. All measurements are nominal. **Please note that weights are only estimated as custom finishes will alter bundle weight.** Contact Unilock for more information.



LAYING PATTERNS

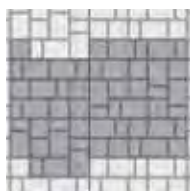

EcoOptiloc Cluster A

APPLICATIONS



APPEARANCE

Edge Detail - Chamfer
 Surface Texture - Smooth
 Joint Spacing - 7mm
 Void - 7.3%

TECHNOLOGIES

PERMEABLE

Can be installed to allow water to flow through

ENDURACOLOR™

Refined surface and long-lasting color

TECHNICAL INFORMATION

Conforms to ASTM C 936
 Eligible for LEED v4.1 credits

ALL FINISHES	
Bundle Type	SINGLE
Plant Produced	ELKHORN / CHICAGO
Thickness (mm)	80 MM

SQFT PER	Bundle	84.80
	Layer	10.60
	Section	-
	Stone	0.50

PER BUNDLE	Layers	8.00
	Sections	-

SOLDIER LNFT PER	SqFt	-
	Section	-
	Layer	-
	Bundle	-

SAILOR LNFT PER	SqFt	-
	Section	-
	Layer	-
	Bundle	-

UNITS PER	SqFt	1.98
	Section	-
	Bundle	168.00

LBS PER	Layer	358
	Section	-
	Bundle	2,860

COLORS	Reflectance	Stock
Custom Colors & Finishes	SR n/a SRI n/a	SO

Please contact your local Sales Representative for color options.



CLASSIC
Thrumix Finish



IL CAMPO®
Brushed Finish



SERIES™
Exposed Granite Finish



SMOOTH
Premier Finish



UMBRIANO®
Mottled Finish with/
ColorFusion and EasyClean

Single Unit



ENDURACOLOR
 250 x 250 x 80mm
 9 7/8" x 9 7/8" x 3 1/8"
 168 Units/Bundle
 .50 SqFt/Stone

Notes: **Special Order - Lead time required.** Minimum quantities apply. **SOLD IN FULL BUNDLES ONLY** and is produced and sold on a required, refundable skid. **Important:** A urethane rubber paver mat must be used to prevent scuffing when compacting on textured surfaces. All measurements are nominal. **Please note that weights are only estimated as custom finishes will alter bundle weight.** Contact Unilock for more information.



APPLICATIONS



APPEARANCE

Edge Detail - Micro
 Surface Texture - Smooth
 Joint Spacing - 7mm
 Void - 4.6-7.08%

TECHNOLOGIES

PERMEABLE

Can be installed to allow water to flow through

CLASSIC

Budget-friendly traditional product mix

ENDURACOLOR™

Refined surface and long-lasting color

TECHNICAL INFORMATION

Conforms to ASTM C 936
 Eligible for LEED v4.1 credits

LAYING PATTERNS

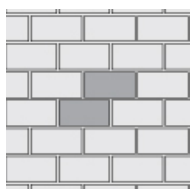

EcoPriora 5x10
RB_A

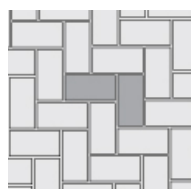

EcoPriora 5x10
HB_E

	SMOOTH CLASSIC	SMOOTH ENDURACOLOR
Bundle Type	SINGLE	SINGLE
Plant Produced	CHICAGO	CHICAGO
Thickness (mm)	80 MM	80 MM

SQFT PER	Bundle	75.95	75.95
	Layer	10.85	10.85
	Section	-	-
	Stone	0.31	0.31

PER BUNDLE	Layers	7.00	7.00
	Sections	-	-

SOLDIER LNFT PER	SqFt	1.27	1.27
	Section	-	-
	Layer	13.78	13.78
	Bundle	96.46	96.46

SAILOR LNFT PER	SqFt	2.54	2.54
	Section	-	-
	Layer	27.56	27.56
	Bundle	192.91	192.91

UNITS PER	SqFt	3.23	3.23
	Section	-	-
	Bundle	245.00	245.00

LBS PER	Layer	381	388
	Section	-	-
	Bundle	2,669	2,717

COLORS	Reflectance	Stock	Stock
Granite	SR .26 SRI 27	-	✓
River	SR .32 SRI 36	✓	-
Sierra	SR n/a SRI n/a	✓	-
Custom Colors & Finishes	SR n/a SRI n/a	SO	SO

Please contact your local Sales Representative for color options.



CLASSIC
Thrumix Finish



IL CAMPO®
Brushed Finish

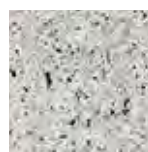

SERIES™
Exposed Granite
Finish



SMOOTH
Premier Finish



UMBRIANO®
Mottled Finish w/
ColorFusion and
EasyClean

Single Units



RECTANGLE (Classic)
 120 x 240 x 80mm
 4 ¾ x 9 ½ x 3 ⅛"
 245 units/Bundle
 .31 Sq.Ft./Stone



RECTANGLE (Enduracolor)
 120 x 240 x 80mm
 4 ¾ x 9 ½ x 3 ⅛"
 245 units/Bundle
 .31 Sq.Ft./Stone

Notes: **Special Order - Lead time required.** Minimum quantities apply. **SOLD IN FULL BUNDLES ONLY** and is produced and sold on a required, refundable skid. **Important:** A urethane rubber paver mat must be used to prevent scuffing when compacting on textured surfaces. All measurements are nominal. **Please note that weights are only estimated as custom finishes will alter bundle weight.** Contact Unilock for more information.



	SMOOTH - CLASSIC	SMOOTH - ENDURA	SERIES™ EXPOSED
Bundle Type	SINGLE	SINGLE	SINGLE
Plant Produced			
Thickness (mm)	100 MM	100 MM	100 MM

SQFT PER	Bundle	63.94	63.94	63.94
	Layer	10.66	10.66	10.66
	Section	-	-	-
	Stone	0.24	0.24	0.24

PER BUNDLE	Layers	6.00	6.00	6.00
	Sections	-	-	-

SOLDIER LNFT PER	SqFt	1.02	1.02	1.02
	Section	-	-	-
	Layer	10.83	10.83	10.83
	Bundle	64.96	64.96	64.96

SAILOR LNFT PER	SqFt	4.06	4.06	4.06
	Section	-	-	-
	Layer	43.31	43.31	43.31
	Bundle	259.84	259.84	259.84

UNITS PER	SqFt	4.13	4.13	4.13
	Section	-	-	-
	Bundle	264.00	264.00	264.00

LBS PER	Layer	465	465	465
	Section	-	-	-
	Bundle	2,789	2,789	2,789

COLORS	Reflectance	Stock	Stock	Stock
Custom Colors & Finishes	SR n/a SRI n/a	SO	SO	SO

Please contact your local Sales Representative for color options.

LAYING PATTERNS

APPLICATIONS

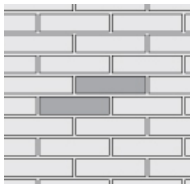

EcoPromenade 3x12 RB_A

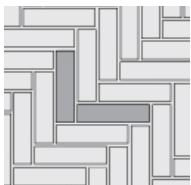

EcoPromenade 3x12 HB_C

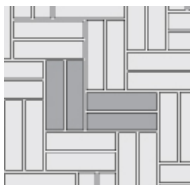

EcoPromenade 3x12 DHB_B



APPEARANCE

Edge Detail - Micro
Surface Texture - Smooth
& Series Exposed
Joint Spacing - 7 mm
Void - 10.12 %

TECHNOLOGIES

PERMEABLE

Can be installed to allow water to flow through

ENDURACOLOR™

Refined surface and long-lasting color

CLASSIC

Budget-friendly traditional product mix

TECHNICAL INFORMATION

Conforms to ASTM C 936
Eligible for LEED v4.1 credits



CLASSIC Thrumix Finish



IL CAMPO® Brushed Finish



SERIES™ Exposed Granite Finish



SMOOTH Premier Finish

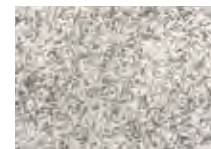

UMBRIANO® Mottled Finish with/ ColorFusion and EasyClean

Single Unit



STANDARD

75 x 300 x 100mm
3 x 11 7/8 x 3 7/8"
264 units/Bundle
.24 Sq.Ft./Stone

Notes: **Special Order - Lead time required.** Minimum quantities apply. **SOLD IN FULL BUNDLES ONLY** and is produced and sold on a required, refundable skid. **Important:** A urethane rubber paver mat must be used to prevent scuffing when compacting on textured surfaces. All measurements are nominal. **Please note that weights are only estimated as custom finishes will alter bundle weight.** Contact Unilock for more information.



APPLICATIONS



APPEARANCE

Edge Detail - Rounded
 Surface Texture - Umbriano Mottled
 Joint Spacing - 3 mm

TECHNOLOGIES

PERMEABLE

Can be installed to allow water to flow through

ENDURACOLOR™

Refined surface and long-lasting color

EASYSOAK™ 

Factory sealed to provide integral stain resistance

COLORFUSION™

Subtly mottled color finish

TECHNICAL INFORMATION

Conforms to ASTM C 936
 Eligible for LEED v4.1 credits

	8" X 8"
Bundle Type	SINGLE
Plant Produced	MARENGO
Thickness (mm)	60 MM

SQFT PER	Bundle	108.31
	Layer	10.83
	Section	-
	Stone	0.45

PER BUNDLE	Layers	10.00
	Sections	-

SOLDIER LNFT PER	SqFt	-
	Section	-
	Layer	-
	Bundle	-

SAILOR LNFT PER	SqFt	-
	Section	-
	Layer	-
	Bundle	-

UNITS PER	SqFt	2.22
	Layer	-
	Bundle	240.00

LBS PER	Layer	276
	Section	-
	Bundle	2,762

COLORS	Reflectance	Stock
French Grey	SR .18 SRI 17	✓
Midnight Sky	SR .17 SRI 15	✓
Winter Marvel	SR .35 SRI 38	✓

LAYING PATTERNS



HexPaver A

Single Unit		HEX
		205 x 205 x 60mm
		8 x 8 x 2 3/8"
		240 Units/Bundle
		.45 SqFt/Stone

Notes: **SOLD IN FULL BUNDLES ONLY** and is produced and sold on a required, refundable skid. **Important:** A urethane rubber paver mat must be used to prevent scuffing when compacting. All measurements are nominal. Contact Unilock for more information.



APPLICATIONS



APPEARANCE

Edge Detail - Chamfer
 Surface Texture - Smooth
 Joint Spacing - 3 mm

TECHNOLOGIES

CLASSIC
 Budget-friendly traditional product mix

TECHNICAL INFORMATION

Conforms to ASTM C 936
 Eligible for LEED v4.1 credits

	4 x 8
Bundle Type	SINGLE
Plant Produced	CHICAGO
Thickness (mm)	60 MM

SQFT PER	Bundle	118.00
	Layer	11.80
	Section	19.67
	Stone	0.22

PER BUNDLE	Layers	10.00
	Sections	6.00

SOLDIER LNFT PER	SqFt	1.50
	Section	29.53
	Layer	17.72
	Bundle	177.17

SAILOR LNFT PER	SqFt	3.00
	Section	59.06
	Layer	35.43
	Bundle	354.33

UNITS PER	SqFt	4.58
	Section	90.00
	Bundle	540.00

LBS PER	Layer	323
	Section	538
	Bundle	3,229

COLORS	Reflectance	Stock
Autumn Red	SR n/a SRI n/a	✓
Charcoal	SR .12 SRI 9	✓
River	SR .32 SRI 34	✓
Sierra	SR n/a SRI n/a	✓

LAYING PATTERNS

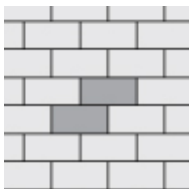

Hollandstone 4x8
RB_B

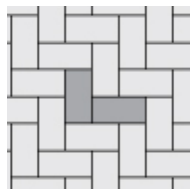

Hollandstone 4x8
HB_C

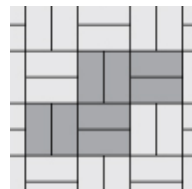

Hollandstone 4x8
BW_D

Single Unit



STANDARD
 100 x 200 x 60mm
 3 7/8 x 7 7/8 x 2 3/8"
 540 units/Bundle
 .22 Sq.Ft./Stone

Notes: **Important:** A urethane rubber paver mat must be used to prevent scuffing when compacting on textured surfaces. All measurements are nominal. Contact Unilock for more information.



	4 x 8	HERRINGBONE
Bundle Type	SINGLE	SINGLE
Plant Produced		
Thickness (mm)	80 MM	80 MM

SQFT PER	Bundle	82.60	82.60
	Layer	11.80	11.80
	Section	-	-
	Stone	0.22	0.22

PER BUNDLE	Layers	7.00	7.00
	Sections	-	-

SOLDIER LNFT PER	SqFt	1.50	1.50
	Section	-	-
	Layer	17.71	17.72
	Bundle	124.00	124.02

SAILOR LNFT PER	SqFt	-	3.00
	Section	-	-
	Layer	-	35.43
	Bundle	-	248.03

UNITS PER	SqFt	4.58	4.58
	Section	-	-
	Bundle	378.00	378.00

LBS PER	Layer	429	423
	Section	-	-
	Bundle	3,005	2,963

COLORS	Reflectance	Stock	Stock
Custom Colors & Finishes	SR n/a SRI n/a	SO	SO

Please contact your local Sales Representative for color options.

LAYING PATTERNS

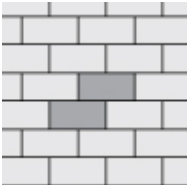

Hollandstone 4x8 RB_B

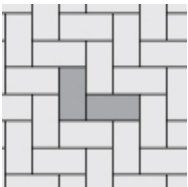

Hollandstone 4x8 HB_C

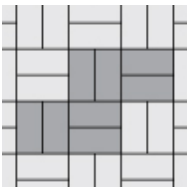

Hollandstone 4x8 BW_D

APPLICATIONS



APPEARANCE

Edge Detail - Chamfer
Surface Texture - Smooth
Joint Spacing - 3 mm

TECHNOLOGIES

CLASSIC
Budget-friendly traditional product mix

TECHNICAL INFORMATION

Conforms to ASTM C 936
Eligible for LEED v4.1 credits



CLASSIC SMOOTH Thrumix Finish



ENDURACOLOR™ Facemix Finish



SERIES™ Exposed Granite Finish

Single Unit



STANDARD
100 x 200 x 80mm
3 7/8 x 7 7/8 x 3 1/8"
378 units/Bundle
.22 Sq.Ft./Stone

Notes: **Special Order - Lead time required.** Minimum quantities apply. **SOLD IN FULL BUNDLES ONLY** and is produced and sold on a required, refundable skid. **Important:** A urethane rubber paver mat must be used to prevent scuffing when compacting on textured surfaces. All measurements are nominal. **Please note that weights are only estimated as custom finishes will alter bundle weight.** Contact Unilock for more information.



APPLICATIONS



APPEARANCE

Edge Detail - Rounded
 Surface Texture - Smooth
 Joint Spacing - 3 mm

TECHNOLOGIES

ENDURACOLOR™
 Refined surface and long-lasting color

TECHNICAL INFORMATION

Conforms to ASTM C 936
 Eligible for LEED v4.1 credits

LAYING PATTERNS

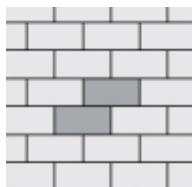

Holland Premier
4x8 RB_B

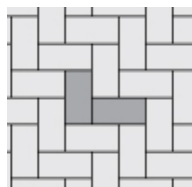

Holland Premier
4x8 HB_C

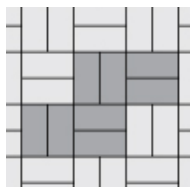

Holland Premier
4x8 BW_D

		4 x 8
Bundle Type		SINGLE
Plant Produced		CHICAGO
Thickness (mm)		60 MM
SQFT PER	Bundle	118.00
	Layer	11.80
	Section	-
	Stone	0.22
PER BUNDLE	Layers	10.00
	Sections	-
SOLDIER LNFT PER	SqFt	1.50
	Section	-
	Layer	17.72
	Bundle	177.17
SAILOR LNFT PER	SqFt	3.00
	Section	-
	Layer	35.43
	Bundle	354.33
UNITS PER	SqFt	4.58
	Section	-
	Bundle	540.00
LBS PER	Layer	327
	Section	-
	Bundle	3,270

COLORS	Reflectance	Stock
Charleston	SR n/a SRI n/a	✓
Dark Charcoal	SR n/a SRI n/a	✓
Granite	SR n/a SRI n/a	✓
Heritage Brown	SR n/a SRI n/a	✓
Ivory NEW	SR n/a SRI n/a	✓
River	SR .22 SRI 19	✓
Sierra	SR n/a SRI n/a	✓

Single Unit



STANDARD
 100 x 200 x 60mm
 3 7/8 x 7 7/8 x 2 3/8"
 540 units/Bundle
 .22 Sq.Ft./Stone

Notes: **SOLD IN FULL BUNDLES ONLY** and is produced and sold on a required, refundable skid. **Important:** A urethane rubber paver mat must be used to prevent scuffing when compacting on textured surfaces. All measurements are nominal. Contact Unilock for more information.



APPLICATIONS



APPEARANCE

Edge Detail - Zero
 Surface Texture - Smooth
 Joint Spacing - 3 mm

TECHNOLOGIES

ENDURACOLOR™
 Refined surface and long-lasting color

ANTIQUED™
 Distressed, timeworn finish

TECHNICAL INFORMATION

Conforms to ASTM C 936
 Eligible for LEED v4.1 credits

		SMOOTH ENDURACOLOR	SMOOTH ENDURACOLOR
Bundle Type		SINGLE	SINGLE
Plant Produced		MARENGO	MARENGO
Thickness (mm)		70 MM	60 MM
SQFT PER	Bundle	89.28	111.60
	Layer	11.16	11.16
	Section	-	-
	Stone	0.16	0.16
PER BUNDLE	Layers	8.00	10.00
	Sections	-	-
SOLDIER LNFT PER	SqFt	1.27	1.27
	Section	-	-
	Layer	14.17	14.17
	Bundle	113.39	141.73
SAILOR LNFT PER	SqFt	5.08	5.08
	Section	-	-
	Layer	56.69	56.69
	Bundle	453.54	566.92
UNITS PER	SqFt	6.45	6.45
	Section	-	-
	Bundle	576.00	720.00
LBS PER	Layer	349	306
	Section	-	-
	Bundle	2,793	3,062

COLORS	Reflectance	Stock	COMING MID-SEASON
Cocoa Brown	SR n/a SRI n/a	✓	✓
Dark Charcoal	SR n/a SRI n/a	✓	✓
Granite Fusion	SR n/a SRI n/a	✓	✓
Sable	SR n/a SRI n/a	✓	✓

LAYING PATTERNS

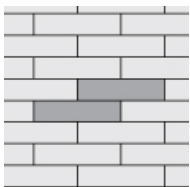

Mattoni RB_A

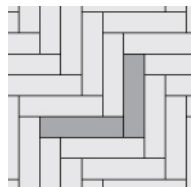

Mattoni HB_C

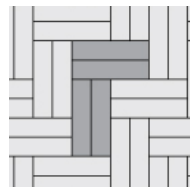

Mattoni DHB_D

Single Unit



STANDARD
 60 x 240 x 70mm
 2 3/8 x 9 1/2 x 2 3/4"
 576 Units/Bundle
 .16 SqFt/Stone

Notes: **SOLD IN FULL BUNDLES ONLY** and is produced and sold on a required, refundable skid. **Important:** A urethane rubber paver mat must be used to prevent scuffing when compacting. All measurements are nominal. Contact Unilock for more information.



BRUSHED FINISH	12" X 24"	18" X 24"	24" X 24"	24" X 36"
Bundle Type	SINGLE	SINGLE	SINGLE	SINGLE
Thickness (mm)	22 MM	22 MM	22 MM	22 MM

SQFT PER	Crate	180.00	186.00	160.00	180.00
	Units	2.00	3.00	4.00	6.00

UNITS PER	Crate	90.00	62.00	40.00	30.00
	SqFt	0.50	0.33	0.25	0.17

LBS PER	Unit	24	36	48	72
	Bundle	2,149	2,221	1,910	2,149

APPLICATIONS



APPEARANCE

Edge Detail - Sawn Edge
Surface Texture - Brushed / Riven

COLORS	Reflectance	Stock	Stock	Stock	Stock
Autumn Harvest (Riven)	SR n/a SRI n/a	✓	✓	✓	✓
Golden Sand (Brushed)	SR n/a SRI n/a	✓	✓	✓	✓
Ivory Sand (Brushed)	SR n/a SRI n/a	✓	✓	✓	✓
Stone Cliff Grey (Riven)	SR n/a SRI n/a	✓	✓	✓	✓

TECHNICAL INFORMATION

More information is available online.

LAYING PATTERNS

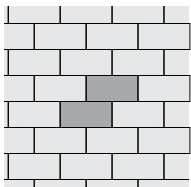

NaturalStone
12x24 RB A

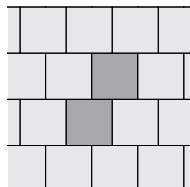

NaturalStone 24x24
RB B

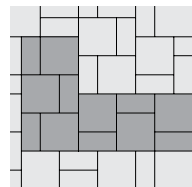

NaturalStone Multi-
Unit C

Single Units



12 X 24"
300 x 600 x 22mm
11 7/8 x 23 5/8 x 7/8"
2.0 Sq.Ft./Stone



18 X 24"
450 x 600 x 22mm
17 3/4 x 23 5/8 x 7/8"
3.0 Sq.Ft./Stone



24 X 24"
600 x 600 x 22mm
23 5/8 x 23 5/8 x 7/8"
4.0 Sq.Ft./Stone



24 X 36"
600 x 900 x 22mm
23 5/8 x 35 1/2 x 7/8"
6.0 Sq.Ft./Stone

Notes: **SOLD IN FULL CRATES ONLY.** This product is not intended for vehicular applications. Unilock offers adjustable pedestals. ** Product is only available to dealers. ** Please see important notice on page 86 regarding installation practices. **Important:** A urethane rubber paver mat must be used to prevent scuffing when compacting. All measurements are nominal. Contact Unilock for more information.

Natural Stone - Sandstone

Steps, Coping and Pillar Cap



APPLICATIONS



APPEARANCE

Edge Detail - Rock Faced
Surface Texture - Brushed / Riven

TECHNICAL INFORMATION

More information is available online.

		48" X 16" STEP
Bundle Type		SINGLE
Thickness (mm)		150 MM
FCFT PER	Crate	32.00
LNFT PER	Crate	24.00
UNITS PER	Crate	6.00
LBS PER	Unit	421
	Bundle	2,526
COLORS		Stock
Ivory Sand		✓

	48 X 12" 4' FULLNOSE COPING	48 X 12" 4' ROCK FACED COPING	48 X 14" 4' ROCK FACED COPING	24 X 24" PILLAR CAP	28 X 28" PILLAR CAP
Bundle Type	SINGLE	SINGLE	SINGLE	SINGLE	SINGLE
Thickness (mm)	50 MM	50 MM	50 MM	65 MM	65 MM

UNITS PER	Crate	20.00	20.00	20.00	14.00	12.00
	SqFt	-	-	-	-	-

LBS PER	Unit	106	106	128	186	200
	Bundle	2,116	2,122	2,552	2,606	2,402

COLORS	Stock	Stock	Stock	Stock	Stock
Golden Sand	✓	✓	-	SO	SO
Ivory Sand	✓	✓	-	✓	SO
Stone Cliff Grey	✓	✓	✓	SO	SO

Pillar Caps	24 X 24 PILLAR CAP	28 X 28 PILLAR CAP
	600 x 600 x 65mm 23 5/8 x 23 5/8 x 2 5/8" Ivory Sand Only	725 x 725 x 65mm 28 5/8 x 28 5/8 x 2 5/8" SPECIAL ORDER

Step & Coping	48 X 16" STEP	4' FULLNOSE 48x12"	4' ROCK FACE 48x12"	4' ROCK FACE 48x14"
	1,200 x 150 x 400mm 47 1/4 x 5 7/8 x 15 3/4" Ivory Sand Only	1,200 x 50 x 300mm 47 1/4 x 2 x 11 7/8"	1,200 x 50 x 300mm 47 1/4 x 2 x 11 7/8"	1,200 x 50 x 350mm 47 1/4 x 2 x 13 7/8" Stone Cliff Grey Only



	12" X 24"	18" X 24"	24" X 24"	24" X 36"
Bundle Type	SINGLE	SINGLE	SINGLE	SINGLE
Thickness (mm)	22 MM	22 MM	22 MM	22 MM

SQFT PER	Crate	180.00	186.00	160.00	180.00
	Units	2.00	3.00	4.00	6.00

UNITS PER	Crate	90.00	62.00	40.00	30.00
	SqFt	0.50	0.33	0.25	0.17

LBS PER	Unit	24	36	48	72
	Bundle	2,149	2,221	1,910	2,149

COLORS	Reflectance	Stock	Stock	Stock	Stock
Black River	SR n/a SRI n/a	✓	✓	✓	✓

APPLICATIONS



APPEARANCE

Edge Detail - Sawn Edge

Surface Texture - Riven

TECHNICAL INFORMATION

More information is available online.

LAYING PATTERNS

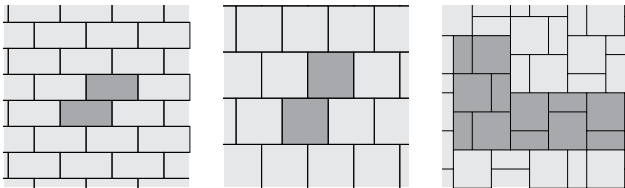

Pattern 12x24 RB A Pattern 24x24 RB B Pattern Multi-Unit C

Single Units				
	12 X 24"	18 X 24"	24 X 24"	24 X 36"
	300 x 600 x 22mm	450 x 600 x 22mm	600 x 600 x 22mm	600 x 900 x 22mm
	11 7/8 x 23 5/8 x 7/8"	17 3/4 x 23 5/8 x 7/8"	23 5/8 x 23 5/8 x 7/8"	23 5/8 x 35 1/2 x 7/8"
	2.0 Sq.Ft./Stone	3.0 Sq.Ft./Stone	4.0 Sq.Ft./Stone	6.0 Sq.Ft./Stone

Notes: **SOLD IN FULL CRATES ONLY.** Natural Stone is available for purchase by Unilock Authorized Dealers only. Unilock offers adjustable and stackable pedestal system; please contact your Territory Manager for pricing and availability. Due to natural oxidation, the Black River Limestone will require sealing to maintain its deep rich color. Unilock recommends a solvent-based sealer for natural stone. Please see important notice on page 86 regarding installation practices. **Important:** Natural Stone is covered under Unilock's Transferable Lifetime Guarantee. All measurement are nominal. **Product is not intended for vehicular applications.**



	48 X 12" ROCK FACED COPING	48 X 14" ROCK FACED COPING	24" ROCK FACED PILLAR CAP	28" ROCK FACED PILLAR CAP
Bundle Type	SINGLE	SINGLE	SINGLE	SINGLE
Thickness (mm)	50 MM	50 MM	64 MM	64 MM

UNITS PER	Crate	20.00	20.00	14.00	12.00
	SqFt	-	-	-	-

LBS PER	Unit	106	128	186	200
	Bundle	2,122	2,552	2,606	2,402

COLORS	Stock	Stock	Stock	Stock
Black River	✓	✓	✓	✓

APPLICATIONS



APPEARANCE

Edge Detail - Rock Faced
Surface Texture - Riven

TECHNICAL INFORMATION

More information is available online.

	48" X 16" STEP
Bundle Type	SINGLE
Thickness (mm)	150 MM





FCFT PER	Crate	32.00
-----------------	-------	-------

LNFT PER	Crate	24.00
-----------------	-------	-------

UNITS PER	Crate	6.00
------------------	-------	------

LBS PER	Unit	421
	Bundle	2,526

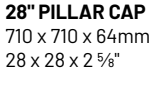
COLORS	Stock
Black River	✓

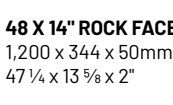
48" Step		48 X 16" STEP 1,200 x 150 x 400mm 47 1/4 x 5 7/8 x 15 3/4"		
Pillar Cap		24" PILLAR CAP 600 x 600 x 64mm 23 5/8 x 23 5/8 x 2 5/8"		28" PILLAR CAP 710 x 710 x 64mm 28 x 28 x 2 5/8"
Coping		48 X 12" ROCK FACE 1,200 x 300 x 50mm 47 1/4 x 11 7/8 x 2"		48 X 14" ROCK FACE 1,200 x 344 x 50mm 47 1/4 x 13 5/8 x 2"

Notes: Due to natural oxidation, the Black River Limestone will require sealing to maintain its deep rich color. Unilock recommends a solvent-based sealers for natural stone. All measurements are nominal. **Product is not intended for vehicular applications.**



APPLICATIONS



APPEARANCE

Edge Detail - Zero

Surface Texture - Series Exposed

TECHNOLOGIES

PERMEABLE

Can be installed to allow water to flow through

ENDURACOLOR™

Refined surface and long-lasting color

TECHNICAL INFORMATION

Conforms to ASTM C 936

Eligible for LEED v4.1 credits

		SERIES EXPOSED TRAPEZOID
Bundle Type		SINGLE
Plant Produced		CHICAGO
Thickness (mm)		60 MM

SQFT PER	Bundle	78.60
	Layer	9.83
	Section	-
	Stone	0.05

PER BUNDLE	Layers	8.00
	Sections	-

SOLDIER LNFT PER	SqFt	3.39
	Section	-
	Layer	33.31
	Bundle	266.46

SAILOR LNFT PER	SqFt	-
	Section	-
	Layer	-
	Bundle	-

UNITS PER	SqFt	21.98
	Section	-
	Bundle	864

LBS PER	Layer	243
	Section	-
	Bundle	1,942

COLORS	Reflectance	Stock
Cobalt Grey	SR n/a SRI n/a	✓
Onyx Black	SR n/a SRI n/a	✓

LAYING PATTERNS

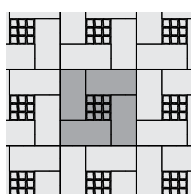

NordicCobble_A

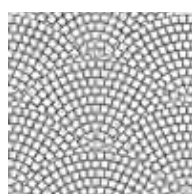

NordicCobble_Fan

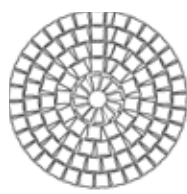

NordicCobble_Circle

Single Unit



STANDARD

89.9 x 94 x 60mm

3 5/8 x 3 3/4 x 2 3/8"

864 units/Bundle

.05 Sq.Ft./Stone

Notes: **SOLD IN FULL BUNDLES ONLY** and is produced and sold on a required, refundable skid. **Important:** A urethane rubber paver mat must be used to prevent scuffing when compacting on textured surfaces. All measurements are nominal. Contact Unilock for more information.



LAYING PATTERNS

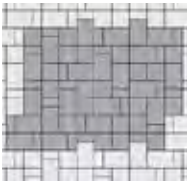

Optiloc A

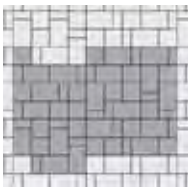

Optiloc B

APPLICATIONS



APPEARANCE

Edge Detail - Chamfer
Surface Texture - Smooth & Series™ Exposed
Joint Spacing - 3 mm

TECHNOLOGIES

ENDURACOLOR™

Refined surface and long-lasting color

TECHNICAL

INFORMATION

Conforms to ASTM C 936
Eligible for LEED v4.1 credits

		ALL FINISHES
Bundle Type		SINGLE
Plant Produced		
Thickness (mm)		80 MM

SQFT PER	Bundle	77.33
	Layer	9.67
	Section	-
	Stone	0.54

PER BUNDLE	Layers	8.00
	Sections	-

SOLDIER LNFT PER	SqFt	1.59
	Section	-
	Layer	15.35
	Bundle	122.83

SAILOR LNFT PER	SqFt	1.59
	Section	-
	Layer	15.35
	Bundle	122.83

UNITS PER	SqFt	1.86
	Section	-
	Bundle	144.00

LBS PER	Layer	350
	Section	-
	Bundle	2,801

COLORS	Reflectance	Stock
Custom Colors & Finishes		SO
Please contact your local Sales Representative for color options.		



CLASSIC
Thrumix Finish



IL CAMPO®
Brushed Finish



SERIES™
Exposed Granite Finish



SMOOTH
Premier Finish



UMBRIANO®
Mottled Finish with/
ColorFusion and EasyClean

Single Unit



STANDARD

260 x 260 x 80mm
10 ¼ x 10 ¼ x 3 ⅞"
144 units/Bundle
.54 Sq.Ft./Stone

Notes: **Special Order - Lead time required.** Minimum quantities apply. **SOLD IN FULL BUNDLES ONLY** and is produced and sold on a required, refundable skid. **Important:** A urethane rubber paver mat must be used to prevent scuffing when compacting on textured surfaces. All measurements are nominal. **Please note that weights are only estimated as custom finishes will alter bundle weight.** Contact Unilock for more information.



APPLICATIONS



APPEARANCE

Surface Texture - Stone Finish

TECHNICAL INFORMATION

More information is available online.

	DEL CONCA SQUARE PRESSED EDGE	CAESAR SQUARE SAWN EDGE	DEL CONCA COPING
Bundle Type	SINGLE	SINGLE	SINGLE
Thickness (mm)	20 MM	20 MM	30 MM

SQFT PER	Pallet	248.00	232.50	-
	Box	7.75	7.75	-
	Unit	3.88	3.88	-

PER PALLET	Box	32.00	30.00	38.00
	SqFt	248.00	232.50	-
	Unit	64.00	60.00	38.00

UNITS PER	Pallet	64.00	60.00	38.00
	Box	2.00	2.00	1.00

LBS PER	Unit	36	36	30
	SqFt	9	9	-
	Box	72	73	30
	Pallet	2,288	2,178	1,127

COLORS	Reflectance	Stock	Stock	Stock
Chamonix Bianco NEW	SR n/a SRI n/a	✓	-	-
Chamonix Grey NEW	SR n/a SRI n/a	✓	-	-
Gotham Grey	SR n/a SRI n/a	✓	-	✓
Gotham Nero	SR n/a SRI n/a	✓	-	-
Travstone Beige	SR n/a SRI n/a	✓	-	✓
Eikon Gea	SR n/a SRI n/a	-	✓	-
Eikon Titanio	SR n/a SRI n/a	-	✓	-

LAYING PATTERNS

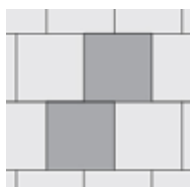

Porcelain 24x24
RB_A

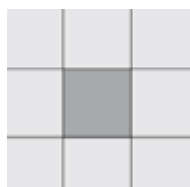

Porcelain 24x24
SB_B

Single Units



DEL CONCA SQUARE
 600 x 600 x 20mm
 23 5/8 x 23 5/8 x 1/8"
 3.88 Sq.Ft./Stone



CAESAR SQUARE
 600 x 600 x 20mm
 23 5/8 x 23 5/8 x 1/8"
 3.88 Sq.Ft./Stone



DEL CONCA COPING
 330 x 600 x 30mm
 13 x 23 5/8 x 1 1/4"

Notes: **SOLD IN FULL CRATES ONLY.** Porcelain tile is available for purchase by Unilock Authorized Dealers only. **Important: A urethane rubber paver mat must be used to prevent scuffing when compacting on textured surfaces.** All measurements are nominal. Contact Unilock for more information. Porcelain tile is not covered by Unilock's Lifetime Guarantee. Please contact your Territory Manager for more information. **Product is not intended for vehicular applications.**



APPLICATIONS



APPEARANCE

Surface Texture - Woodgrain Finish (DelConca) & Stone Finish

TECHNICAL INFORMATION

More information is available online.

	DEL CONCA RECTANGLE PRESSED EDGE	UNILOCK RECTANGLE PRESSED EDGE
Bundle Type	SINGLE	SINGLE
Thickness (mm)	20 MM	20 MM

SQFT PER	Pallet	165.36	186.00
	Box	6.89	6.89
	Unit	3.45	3.44

PER PALLET	Box	24.00	27.00
	SqFt	165.36	186.00
	Unit	48.00	54.00

UNITS PER	Pallet	48.00	54.00
	Box	2.00	2.00

LBS PER	Unit	32	32
	SqFt	9	9
	Box	64	64
	Pallet	1,538	1,726

COLORS	Reflectance	Stock	Stock
Cosmic Grey	SR n/a SRI n/a	-	✓
Dove Grey Travertine	SR n/a SRI n/a	-	✓
Quartzite Dark Gray NEW	SR n/a SRI n/a	✓	-
Quartzite Sand NEW	SR n/a SRI n/a	✓	-

LAYING PATTERNS



Porcelain 16x32
RB_C

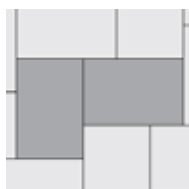

Porcelain 16x32
HB_D

Single Unit



DEL CONCA RECTANGLE

400 x 800 x 20mm
15 3/4 x 31 1/2 x 7/8"
3.45 Sq.Ft./Stone



UNILOCK RECTANGLE

400 x 800 x 20mm
15 3/4 x 31 1/2 x 7/8"
3.44 Sq.Ft./Stone

Notes: **SOLD IN FULL CRATES ONLY.** Porcelain tile is available for purchase by Unilock Authorized Dealers only. **Important: A urethane rubber paver mat must be used to prevent scuffing when compacting on textured surfaces.** All measurements are nominal. Contact Unilock for more information. Porcelain tile is not covered by Unilock's Lifetime Guarantee. Please contact your Territory Manager for more information. **Product is not intended for vehicular applications.**



APPLICATIONS



APPEARANCE

Surface Texture - Stone Finish

TECHNICAL INFORMATION

More information is available online.

		DEL CONCA MODULAR BUNDLE
Bundle Type		RANDOM
Thickness (mm)		20 MM
SQFT PER	Pallet	434.00
	Box	-
	Unit	-
PER PALLET	Box	-
	SqFt	-
	Unit	-
UNITS PER	Pallet	192
	Box	-
LBS PER	Unit	-
	SqFt	-
	Box	-
	Pallet	3,973
COLORS		Reflectance
Travestone Beige		SR n/a SRI n/a
		Stock
		✓

LAYING PATTERNS

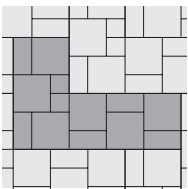

Porcelain Fixed
Random_G

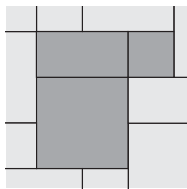

Porcelain Fixed
Random_H

Modular Bundle



12x12
300 x 300 x 20mm
11 7/8 x 11 7/8 x 7/8"
64 units/62 Sq.Ft.



12x24
300 x 600 x 20mm
11 7/8 x 23 5/8 x 7/8"
64 units/124 Sq.Ft.



24x24
600 x 600 x 20mm
23 5/8 x 23 5/8 x 7/8"
64 units/248 Sq.Ft.

Notes: **SOLD IN FULL CRATES ONLY.** All measurements are nominal. Contact Unilock for more information. Porcelain tile is not covered by Unilock's Lifetime Guarantee. Please contact your Territory Manager for more information. **Product is not intended for vehicular applications.**



APPLICATIONS



APPEARANCE

Edge Detail - Rounded
 Surface Texture - Multi-Finishes Available
 Joint Spacing - 4 mm

TECHNOLOGIES

ENDURACOLOR™

Refined surface and long-lasting color

TECHNICAL INFORMATION

Conforms to ASTM C 936
 Eligible for LEED v4.1 credits

	6X24	6X24 UMBRIANO MOTTLED
Bundle Type	SINGLE	SINGLE
Plant Produced		
Thickness (mm)	70 MM	150 MM

SQFT PER	Bundle	93.00	46.50
	Layer	11.63	11.63
	Section	-	-
	Stone	0.97	0.97

PER BUNDLE	Layers	8.00	4.00
	Sections	-	-

SOLDIER LNFT PER	SqFt	0.51	0.51
	Section	-	-
	Layer	5.91	5.91
	Bundle	47.24	23.62

SAILOR LNFT PER	SqFt	2.03	2.03
	Section	-	-
	Layer	23.62	23.62
	Bundle	188.98	94.49

UNITS PER	SqFt	1.03	1.03
	Section	-	-
	Bundle	96.00	48.00

LBS PER	Layer	372	798
	Section	-	-
	Bundle	2,978	3,192

COLORS	Reflectance	Stock	Stock
Custom Colors & Finishes	SR n/a SRI n/a	SO	SO

LAYING PATTERN



CLASSIC
Thrumix Finish



SERIES™
Exposed Granite Finish



SMOOTH
Premier Finish



UMBRIANO®
Mottled Finish with/ColorFusion
and EasyClean

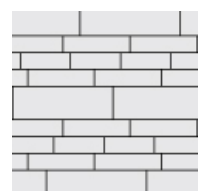

Promenade Multi-Unit Random G

Single Units		6" X 24" 150 x 600 x 70mm 5 7/8 x 23 5/8 x 2 3/4" 96 units/Bundle .97 Sq.Ft./Stone		6" X 24" UMBRIANO 150 x 600 x 150mm 5 7/8 x 23 5/8 x 2 3/4" 48 units/Bundle .97 Sq.Ft./Stone
--------------	---	---	---	---

Notes: **Special Order - Lead time required.** Minimum quantities apply. **SOLD IN FULL BUNDLES ONLY** and is produced and sold on a required, refundable skid. **Important:** A urethane rubber paver mat must be used to prevent scuffing when compacting on textured surfaces. All measurements are nominal. **Please note that weights are only estimated as custom finishes will alter bundle weight.** Contact Unilock for more information.



	ALL FINISHES 3 X 12	ALL FINISHES 4 X 12	ALL FINISHES 4 X 16	ALL FINISHES 8 X 24
Bundle Type	SINGLE	SINGLE	SINGLE	SINGLE
Plant Produced	CHICAGO	CHICAGO	MARENGO	CHICAGO
Thickness (mm)	100 MM	100 MM	100 MM	100 MM

SQFT PER	Bundle	63.94	58.13	51.67	51.67
	Layer	10.66	11.63	10.33	10.33
	Section	-	-	-	-
	Stone	0.24	0.32	0.43	1.29

PER BUNDLE	Layers	6.00	5.00	5.00	5.00
	Sections	-	-	-	-

SOLDIER LNFT PER	SqFt	1.35	1.02	0.76	0.51
	Section	-	-	-	-
	Layer	14.44	11.81	7.87	5.25
	Bundle	86.61	59.06	39.37	26.25

SAILOR LNFT PER	SqFt	4.06	3.05	3.05	1.52
	Section	-	-	-	-
	Layer	43.31	35.43	31.50	15.75
	Bundle	259.84	177.17	157.48	78.74

UNITS PER	SqFt	4.13	3.10	2.32	0.77
	Section	-	-	-	-
	Bundle	264.00	180.00	120.00	40.00

LBS PER	Layer	465	532	469	483
	Section	-	-	-	-
	Bundle	2,789	2,659	2,345	2,414

COLORS	Reflectance	Stock	Stock	Stock	Stock
Custom Colors & Finishes	SR n/a SRI n/a	SO	SO	SO	SO

Please contact your local Sales Representative for color options.

LAYING PATTERNS

APPLICATIONS

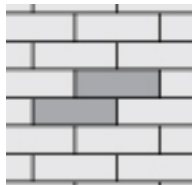

Promenade 4x12
RB_H

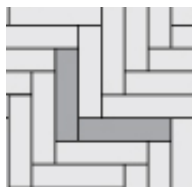

Promenade 4x16
HB_C

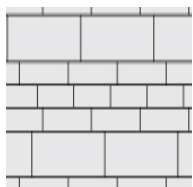

Promenade Multi-Unit
Random G



APPEARANCE

Edge Detail - Rounded
Surface Texture - Multi-Finish
Available
Joint Spacing - 4 mm

TECHNOLOGIES

CLASSIC
Budget-friendly traditional product mix

ENDURACOLOR™

Refined surface and long-lasting color

TECHNICAL INFORMATION

Conforms to ASTM C 936
Eligible for LEED v4.1 credits



CLASSIC
Thrumix Finish



IL CAMPO®
Brushed Finish



SERIES™
Exposed Granite Finish



SMOOTH
Premier Finish



UMBRIANO®
Mottled Finish with/
ColorFusion and EasyClean

Single Units	3" X 12"	4" X 12"	4" X 16"	8" X 24"
	75 x 300 x 100mm 3 x 11 7/8 x 3 7/8" 264 units/Bundle .24 Sq.Ft./Stone	100 x 300 x 100mm 3 7/8 x 11 7/8 x 3 7/8" 180 units/Bundle .32 Sq.Ft./Stone	100 x 400 x 100mm 3 7/8 x 15 3/4 x 3 7/8" 120 units/Bundle .43 Sq.Ft./Stone	200 x 600 x 100mm 7 7/8 x 23 5/8 x 3 7/8" 40 units/Bundle 1.29 Sq.Ft./Stone

Notes: **Special Order - Lead time required.** Minimum quantities apply. **SOLD IN FULL BUNDLES ONLY** and is produced and sold on a required, refundable skid. **Important:** A urethane rubber paver mat must be used to prevent scuffing when compacting on textured surfaces. All measurements are nominal. **Please note that weights are only estimated as custom finishes will alter bundle weight.** Contact Unilock for more information.



APPLICATIONS



APPEARANCE

Surface Texture - Textured

Joint Spacing - 10 mm

TECHNOLOGIES

ELEGANCE™

Timeless, long-lasting beauty with the combination of Reala and Ultima technologies

EASYCLEAN™ 

Factory sealed to provide integral stain resistance

REALA™

Cast from natural stone

ULTIMA™

Up to 4x stronger than poured-in-place concrete

TECHNICAL INFORMATION

Conforms to ASTM C 936

Eligible for LEED v4.1 credits

		LARGE RECTANGLE	
Bundle Type	RANDOM	SINGLE	
Plant Produced	AYR	AYR	
Thickness (mm)	60 MM	60 MM	

SQFT PER	Bundle	90.30	82.39
	Layer	11.29	10.30
	Section	-	-
	Stone	-	1.72

PER BUNDLE	Layers	8.00	8.00
	Sections	-	-

SOLDIER LNFT PER	SqFt	-	0.58
	Section	-	-
	Layer	-	5.94
	Bundle	-	47.56

SAILOR LNFT PER	SqFt	1.31	1.01
	Section	-	-
	Layer	14.78	10.39
	Bundle	118.22	83.15

UNITS PER	SqFt	-	0.58
	Section	-	-
	Bundle	160.00	48.00

LBS PER	Layer	309	301
	Section	-	-
	Bundle	2,472	2,411

COLORS	Reflectance	Stock	Stock
Dawn Mist	SR n/a SRI n/a	✓	✓
Pebble Taupe	SR n/a SRI n/a	✓	✓

LAYING PATTERNS



Richcliff Fixed Random A

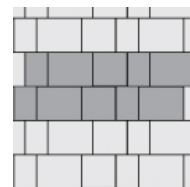

Richcliff Fixed Random B



Richcliff LargeRec HB_H

3 Unit Random Bundle				Single Unit	
	RECTANGLE 226 x 300 x 60mm 8 7/8 x 11 7/8 x 2 3/8" 64 Units/Bundle .75 SqFt./Stone	SQUARE 226 x 226 x 60mm 8 7/8 x 8 7/8 x 2 3/8" 32 units/Bundle .58 Sq.Ft./Stone	SMALL RECTANGLE 150 x 226 x 60mm 5 7/8 x 8 7/8 x 2 3/8" 64 units/Bundle .38 Sq.Ft./Stone		LARGE RECTANGLE 302 x 528 x 60mm 11 7/8 x 20 7/8 x 2 3/8" 48 units/Bundle 1.72 Sq.Ft./Stone

Notes: **SOLD IN FULL BUNDLES ONLY** and is produced and sold on a required, refundable skid. **Important:** A urethane rubber paver mat must be used to prevent scuffing when compacting. All measurements are nominal. Contact Unilock for more information.



APPLICATIONS



APPEARANCE

Edge Detail - Chamfer
 Surface Texture - Series Exposed
 Joint Spacing - 3 mm

TECHNOLOGIES

ENDURACOLOR™
 Refined surface and long-lasting color

TECHNICAL INFORMATION

Conforms to ASTM C 936
 Eligible for LEED v4.1 credits

		4 X 8	
Bundle Type		SINGLE	
Plant Produced		CHICAGO	
Thickness (mm)		60 MM	
SQFT PER	Bundle	117.90	
	Layer	11.79	
	Section	19.67	
	Stone	0.22	
PER BUNDLE	Layers	10.00	
	Sections	6.00	
SOLDIER LNFT PER	SqFt	1.50	
	Section	29.53	
	Layer	17.72	
	Bundle	177.17	
SAILOR LNFT PER	SqFt	3.01	
	Section	59.06	
	Layer	35.43	
	Bundle	354.33	
UNITS PER	SqFt	4.58	
	Section	90.00	
	Bundle	540.00	
LBS PER	Layer	306	
	Section	511	
	Bundle	3,065	
COLORS		Reflectance	Stock
Golden Tan	SR n/a SRI n/a		✓
Onyx Black	SR n/a SRI n/a		✓

LAYING PATTERNS

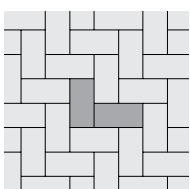

Series_4x8_HB_G

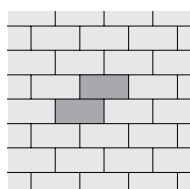

Series_4x8_RB_F

Single Unit



4 X 8
 100 x 200 x 60mm
 3 7/8 x 7 7/8 x 2 3/8"
 540 units/Bundle
 .22 Sq.Ft./Stone

Notes: **SOLD IN FULL BUNDLES ONLY** and is produced and sold on a required, refundable skid. **Important:** A urethane rubber paver mat must be used to prevent scuffing when compacting on textured surfaces. Please refer to the Sealer Best Practices on page 84 and Important Notes on page 86. All measurements are nominal. Contact Unilock for more information.



APPLICATIONS



APPEARANCE

Edge Detail - Chamfer
 Surface Texture - Series Exposed
 Joint Spacing - 3 mm

TECHNOLOGIES

PERMEABLE

Can be installed to allow water to flow through

ENDURACOLOR™

Refined surface and long-lasting color

TECHNICAL INFORMATION

Conforms to ASTM C 936
 Eligible for LEED v4.1 credits

		4 X 12
	Bundle Type	SINGLE
	Plant Produced	CHICAGO
	Thickness (mm)	80 MM

SQFT PER	Bundle	93.04
	Layer	11.63
	Section	-
	Stone	0.32

PER BUNDLE	Layers	8.00
	Sections	-

SOLDIER LNFT PER	SqFt	1.02
	Section	-
	Layer	11.81
	Bundle	94.49

SAILOR LNFT PER	SqFt	3.05
	Section	-
	Layer	35.43
	Bundle	283.46

UNITS PER	SqFt	3.10
	Section	-
	Bundle	288.00

LBS PER	Layer	426
	Section	-
	Bundle	3,404

COLORS	Reflectance	Stock
Arctic Grey	SR n/a SRI n/a	✓
Nordic Star	SR n/a SRI n/a	✓

LAYING PATTERNS

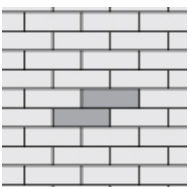

Series 4x12_RB_L

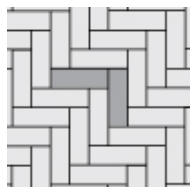

Series4x12_HB_M

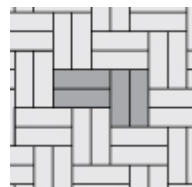

Series 4x12_DHB_N

Single Unit



4 X 12
 100 x 300 x 80mm
 3 7/8 x 11 1/8 x 3 1/8"
 288 units/Bundle
 .32 Sq.Ft./Stone

Notes: **SOLD IN FULL BUNDLES ONLY** and is produced and sold on a required, refundable skid. **Important:** A urethane rubber paver mat must be used to prevent scuffing when compacting on textured surfaces. Please refer to the Sealer Best Practices on page 84 and Important Notes on page 86. All measurements are nominal. Contact Unilock for more information.



APPLICATIONS



APPEARANCE

Edge Detail - Rounded
 Surface Texture - Smooth
 Joint Spacing - 2 mm

TECHNOLOGIES

ENDURACOLOR™
 Refined surface and long-lasting color

TECHNICAL INFORMATION

Conforms to ASTM C 1782
 Eligible for LEED v4.1 credits

	24 X 24
Bundle Type	SINGLE
Plant Produced	MARENGO
Thickness (mm)	50 MM

SQFT PER	Bundle	80.00
	Layer	8.00
	Section	-
	Stone	4.00

PER BUNDLE	Layers	10.00
	Sections	-

SOLDIER LNFT PER	SqFt	0.50
	Section	-
	Layer	4.00
	Bundle	40.00

SAILOR LNFT PER	SqFt	0.50
	Section	-
	Layer	4.00
	Bundle	40.00

UNITS PER	SqFt	0.25
	Section	-
	Bundle	20.00

LBS PER	Layer	183
	Section	-
	Bundle	1,833

COLORS	Reflectance	Stock
Chamois	.41 n/a 46 n/a	✓
Silver Grey NEW	SR n/a SRI n/a	✓

LAYING PATTERNS

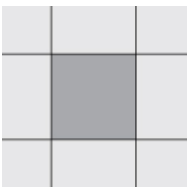

Skyline 24x24_SB_A

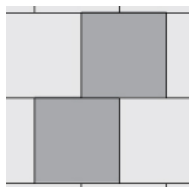

Skyline 24x24_RB_B

Single Unit



24 x 24
 606 x 606 x 50mm
 23 7/8 x 23 7/8 x 2"
 20 units/Bundle
 4.00 Sq.Ft./Stone

Pedestal System
 Contact your local Unilock
 Rep for more information.



Notes: **SOLD IN FULL BUNDLES ONLY** and is produced and sold on a required, refundable skid. **This product is not intended for vehicular applications.** Unilock offers adjustable and stackable pedestal systems; please contact your Territory Manager for pricing and availability. All measurements are nominal.



APPLICATIONS



APPEARANCE

Edge Detail - Micro
Surface Texture - Smooth
Joint Spacing - 0 mm

TECHNOLOGIES

ENDURACOLOR™
Refined surface and long-lasting color

EASYSOAK™ 
Factory sealed to provide integral stain resistance

COMFORT STEP™
Ultra smooth surface texture

TECHNICAL INFORMATION

Conforms to ASTM C 1782
Eligible for LEED v4.1 credits

LAYING PATTERNS

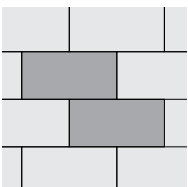

Soreno 16x32 RB_A

	16 X 32
Bundle Type	SINGLE
Plant Produced	CHICAGO
Thickness (mm)	50 MM

SQFT PER	Bundle	64.27
	Layer	3.57
	Section	-
	Stone	3.57

PER BUNDLE	Layers	18.00
	Sections	-

SOLDIER LNFT PER	SqFt	0.37
	Section	-
	Layer	1.34
	Bundle	24.04

SAILOR LNFT PER	SqFt	0.75
	Section	-
	Layer	2.67
	Bundle	48.13

UNITS PER	SqFt	0.28
	Section	-
	Bundle	18.00

LBS PER	Layer	86
	Section	-
	Bundle	1,550

COLORS	Reflectance	Stock
Light Granite	SR n/a SRI n/a	✓
Toscana Beige	SR n/a SRI n/a	✓

Single Units



16 X 32
407 x 815 x 50mm
16 x 32 x 2"
18 units/Bundle
3.57 Sq.Ft./Stone

Pedestal System
Contact your local Unilock
Rep for more information.



Notes: **SOLD IN FULL BUNDLES ONLY** and is produced and sold on a required, refundable skid. **This product is not intended for vehicular applications. Important:** A urethane rubber paver mat must be used to prevent scuffing when compacting. All measurements are nominal. Contact Unilock for more information.



APPLICATIONS



APPEARANCE

Edge Detail - n/a
 Surface Texture - Textured
 Joint Spacing - 10 mm
 Void - 6.5%

TECHNOLOGIES

PERMEABLE

Can be installed to allow water to flow through

ELEGANCE™

Timeless, long-lasting beauty with the combination of Reala and Ultima technologies

EASYCLEAN™ 

Factory sealed to provide integral stain resistance

REALA™

Cast from historical brick

ULTIMA™

Up to 4x stronger than poured-in-place concrete

TECHNICAL INFORMATION

Conforms to ASTM C 936
 Eligible for LEED v4.1 credits

		STANDARD
Bundle Type		SINGLE
Plant Produced		AYR
Thickness (mm)		70 MM
SQFT PER	Bundle	88.41
	Layer	11.05
	Section	-
	Stone	0.28
PER BUNDLE	Layers	8.00
	Sections	-
SOLDIER LNFT PER	SqFt	1.19
	Section	-
	Layer	13.12
	Bundle	104.99
SAILOR LNFT PER	SqFt	2.97
	Section	-
	Layer	32.81
	Bundle	262.47
UNITS PER	SqFt	3.62
	Section	-
	Bundle	320.00
LBS PER	Layer	361
	Section	-
	Bundle	2,888

COLORS	Reflectance	Stock
Basalt	SR n/a SRI n/a	✓
Burgundy Red	SR n/a SRI n/a	✓
Burnt Clay	SR n/a SRI n/a	✓
Old Oak	SR n/a SRI n/a	✓

LAYING PATTERNS



Town Hall 4x10 DHB_B

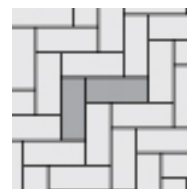

Town Hall 4x10 HB_B

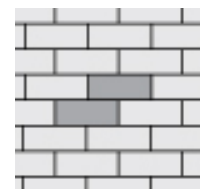

Town Hall 4x10 RB_C

Single Units



STANDARD
 250 x 100 x 70mm
 9 7/8 x 3 7/8 x 2 3/4"
 320 units/Bundle
 .28 Sq.Ft./Stone

Notes: **SOLD IN FULL BUNDLES ONLY** and is produced and sold on a required, refundable skid. **Important:** A urethane rubber paver mat must be used to prevent scuffing when compacting. All measurements are nominal. Contact Unilock for more information.



APPLICATIONS



APPEARANCE

Edge Detail - Rounded
 Surface Texture - Smooth
 Joint Spacing - 7mm
 Void - 5.5%

TECHNOLOGIES

PERMEABLE

Can be installed to allow water to flow through

ENDURACOLOR™

Refined surface and long-lasting color

TECHNICAL INFORMATION

Conforms to ASTM C 936
 Eligible for LEED v4.1 credits

LAYING PATTERNS

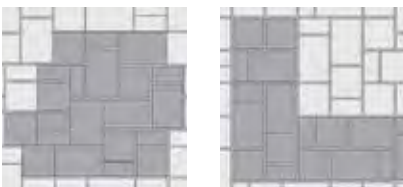

Treo Fixed Random_R Treo Fixed Random_S

	SMOOTH
Bundle Type	RANDOM
Plant Produced	CHICAGO
Thickness (mm)	60 MM

SQFT PER	Bundle	108.99
	Layer	10.90
	Section	-
	Stone	-

PER BUNDLE	Layers	10.00
	Sections	-



SOLDIER LNFT PER	SqFt	-
	Section	-
	Layer	-
	Bundle	-

SAILOR LNFT PER	SqFt	1.35
	Section	-
	Layer	14.76
	Bundle	147.64

UNITS PER	SqFt	-
	Section	-
	Bundle	210.00

LBS PER	Layer	295
	Section	-
	Bundle	2,949

COLORS	Reflectance	Stock
Granite	SR n/a SRI n/a	✓
River	SR n/a SRI n/a	✓
Sierra	SR n/a SRI n/a	✓
Tuscany	SR n/a SRI n/a	✓

Random Bundle		LARGE RECTANGLE 225 x 337.5 x 60mm 8 7/8 x 13 3/8 x 2 3/8" 60 units/Bundle .82 Sq.Ft./Stone		SQUARE 225 x 225 x 60mm 8 7/8 x 8 7/8 x 2 3/8" 70 units/Bundle .55 Sq.Ft./Stone		SMALL RECTANGLE 112.5 x 225 x 60mm 4 1/2 x 8 7/8 x 2 3/8" 80 units/Bundle .27 Sq.Ft./Stone
----------------------	---	--	---	--	---	---

Notes: **SOLD IN FULL BUNDLES ONLY** and is produced and sold on a required, refundable skid. **Important:** A urethane rubber paver mat must be used to prevent scuffing when compacting on textured surfaces. Please refer to the Sealer Best Practices on page 84 and Important Notes on page 86. All measurements are nominal. Contact Unilock for more information.



APPLICATIONS



APPEARANCE

Edge Detail - Micro
 Surface Texture - Series Exposed Textured
 Joint Spacing - 10mm
 Void - 5.6%

TECHNOLOGIES

PERMEABLE

Can be installed to allow water to flow through

ENDURACOLOR™

Refined surface and long-lasting color

TECHNICAL INFORMATION

Conforms to ASTM C 936
 Eligible for LEED v4.1 credits

	SERIES EXPOSED TEXTURED
Bundle Type	RANDOM
Plant Produced	CHICAGO
Thickness (mm)	70 MM

SQFT PER	Bundle	97.53
	Layer	12.19
	Section	-
	Stone	-

PER BUNDLE	Layers	8.00
	Sections	-

SOLDIER LNFT PER	SqFt	-
	Section	-
	Layer	-
	Bundle	-

SAILOR LNFT PER	SqFt	2.34
	Section	-
	Layer	28.49
	Bundle	227.95

UNITS PER	SqFt	-
	Section	-
	Bundle	304.00



LBS PER	Layer	378
	Section	-
	Bundle	3,022

COLORS	Reflectance	Stock
Cobalt Grey	SR n/a SRI n/a	✓
Peppered Granite	SR .38 SRI 42	✓

LAYING PATTERNS



Tribeca Cobble Fixed
 Random_A

Random Bundle		<p>LARGE RECTANGLE 130 x 305 x 70mm 5 x 12 x 2 ¾" 88 units/Bundle .43 Sq.Ft./Stone</p>		<p>RECTANGLE 130 x 230 x 70mm 5 x 9 x 2 ¾" 88 units/Bundle .32 Sq.Ft./Stone</p>		<p>SMALL RECTANGLE 130 x 175 x 70mm 5 x 6 7/8 x 2 ¾" 128 units/Bundle .25 Sq.Ft./Stone</p>
----------------------	---	---	---	--	---	---

Notes: **SOLD IN FULL BUNDLES ONLY** and is produced and sold on a required, refundable skid. **Important: A urethane rubber paver mat must be used to prevent scuffing when compacting on textured surfaces.** For permeable installations, Unilock recommends using granite chips for joint filler. For traditional applications, please refer to the Polymeric Sand Best Practices on page 84 and Important Notes on page 86. All measurements are nominal. Contact Unilock for more information.



APPLICATIONS



APPEARANCE

Edge Detail - Zero
 Surface Texture - Smooth
 Joint Spacing - 2mm
 Void - 40%

TECHNOLOGIES

PERMEABLE

Can be installed to allow water to flow through

CLASSIC

Budget-friendly traditional product mix

TECHNICAL INFORMATION

Conforms to ASTM C 936
 Eligible for LEED v4.1 credits -

		SMOOTH
	Bundle Type	SINGLE
	Plant Produced	
	Thickness (mm)	80 MM
SQFT PER	Bundle	80.00
	Layer	10.00
	Section	-
	Stone	2.50
PER BUNDLE	Layers	8.00
	Sections	-
SOLDIER LNFT PER	SqFt	-
	Section	-
	Layer	-
	Bundle	-
SAILOR LNFT PER	SqFt	-
	Section	-
	Layer	-
	Bundle	-
UNITS PER	SqFt	0.40
	Section	-
	Bundle	32.00
LBS PER	Layer	249
	Section	-
	Bundle	1,995
COLORS		
	Reflectance	Stock
Natural	SR .30 SRI 32	SO

LAYING PATTERNS

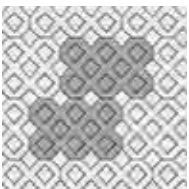

Turfstone A

Single Unit



LARGE RECTANGLE
 400 x 600 x 80mm
 15 3/4 x 23 5/8 x 3 1/8"
 32 units/Bundle
 2.50 Sq.Ft./Stone

Notes: **Special Order - lead time is required.** Minimum quantities apply. **SOLD IN FULL BUNDLES ONLY** and is produced and sold on a required, refundable skid. All measurements are nominal. Contact Unilock for more information.



		XL	4 X 8	8 X 16
Bundle Type	RANDOM	SINGLE	SINGLE	SINGLE
Plant Produced	MARENGO	MARENGO	MARENGO	GEORGETOWN
Thickness (mm)	60 MM	60 MM	60 MM	70 MM

SQFT PER	Bundle	116.57	116.57	118.00	82.67
	Layer	11.66	11.66	11.80	10.33
	Section	-	-	-	-
	Stone	-	5.83	0.22	0.86

PER BUNDLE	Layers	10.00	10.00	10.00	8.00
	Sections	-	-	-	-

SOLDIER LNFT PER	SqFt	-	0.32	1.50	0.76
	Section	-	-	-	-
	Layer	-	3.74	17.72	7.87
	Bundle	-	37.40	159.45	62.99

SAILOR LNFT PER	SqFt	0.80	0.53	3.00	1.52
	Section	-	-	-	-
	Layer	9.35	6.23	35.43	15.75
	Bundle	93.50	62.30	318.90	125.98

UNITS PER	SqFt	-	0.17	4.58	1.16
	Section	-	-	-	-
	Bundle	80.00	20.00	540.00	96.00

LBS PER	Layer	320	320	320	331
	Section	-	-	-	-
	Bundle	3,199	3,199	3,201	2,647

COLORS	Reflectance	Stock	Stock	Stock	Stock
French Grey	SR .18 SRI 17	✓	✓	-	SO
Midnight Sky	SR .17 SRI 15	✓	-	✓	SO
Summer Wheat	SR .42 SRI 48	✓	✓	-	SO
Winter Marvel	SR .35 SRI 38	✓	-	-	SO

APPLICATIONS



APPEARANCE

Edge Detail - Rounded
Surface Texture - Umbriano Mottled
Joint Spacing - 3 mm

TECHNOLOGIES

ENDURACOLOR[™]
Refined surface and long-lasting color

EASYCLEAN[™]

Factory sealed to provide integral stain resistance

COLORFUSION[™]

Subtly mottled colored finish

TECHNICAL INFORMATION

Conforms to ASTM C 936
Eligible for LEED v4.1 credits

LAYING PATTERNS

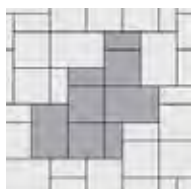

Umbriano Fixed
Random_A

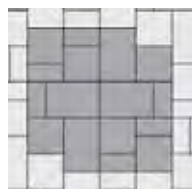

Umbriano Fixed
Random_B

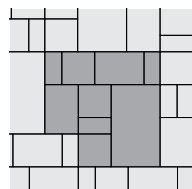

Umbriano Multi-
Unit Random_I

Random Bundle



LARGE RECTANGLE
380 x 570 x 60mm
15 x 22 1/2 x 2 3/8"
20 units/Bundle
2.331 Sq.Ft./Stone



SQUARE
380 x 380 x 60mm
15 x 15 x 2 3/8"
30 units/Bundle
1.554 Sq.Ft./Stone



SMALL RECTANGLE
190 x 380 x 60mm
7 1/2 x 15 x 2 3/8"
30 units/Bundle
.77 Sq.Ft./Stone

Single Units



XL
570 x 950 x 60mm
22 1/2 x 37 1/2 x 2 3/8"
20 units/Bundle
5.83 Sq.Ft./Stone



4x8
100 x 200 x 60mm
4 x 8 x 2 3/8"
540 units/Bundle
.22 Sq.Ft./Stone

Notes: **SOLD IN FULL BUNDLES ONLY** and is produced and sold on a required, refundable skid. **Important: A urethane rubber paver mat must be used to prevent scuffing when compacting on textured surfaces.** Please refer to the Sealer Best Practices on page 84 and Important Notes on page 86. All measurements are nominal. Contact Unilock for more information.



APPLICATIONS



APPEARANCE

Edge Detail - Rounded
 Surface Texture - Umbriano Mottled
 Joint Spacing - 3 mm

TECHNOLOGIES

PERMEABLE

Can be installed to allow water to flow through

ENDURACOLOR™

Refined surface and long-lasting color

EASYCLEAN™ 

Factory sealed to provide integral stain resistance

COLORFUSION™

Subtly mottled colored finish

TECHNICAL INFORMATION

Conforms to ASTM C 936
 Eligible for LEED v4.1 credits

LAYING PATTERNS

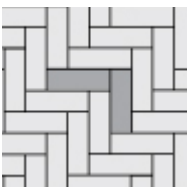

Umbriano 4x12 HB_1

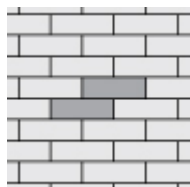

Umbriano 4x12 RB_H

	4 X 12
Bundle Type	SINGLE
Plant Produced	MARENGO
Thickness (mm)	80 MM

SQFT PER	Bundle	93.04
	Layer	11.63
	Section	-
	Stone	0.32

PER BUNDLE	Layers	8.00
	Sections	-

SOLDIER LNFT PER	SqFt	1.02
	Section	-
	Layer	11.81
	Bundle	94.49

SAILOR LNFT PER	SqFt	3.05
	Section	-
	Layer	35.43
	Bundle	283.46

UNITS PER	SqFt	3.10
	Section	-
	Bundle	288.00

LBS PER	Layer	426
	Section	-
	Bundle	3,404

COLORS	Reflectance	Stock
French Grey	SR .18 SRI 17	✓
Midnight Sky	SR .17 SRI 15	✓
Winter Marvel	SR .35 SRI 38	✓

Single Unit



4 X 12
 100 x 300 x 80mm
 3 7/8" x 11 1/8" x 3 1/8"
 288 units/Bundle
 .32 Sq.Ft./Stone

Notes: **SOLD IN FULL BUNDLES ONLY** and is produced and sold on a required, refundable skid. **Important: A urethane rubber paver mat must be used to prevent scuffing when compacting on textured surfaces.** Please refer to the Sealer Best Practices on page 84 and Important Notes on page 86. All measurements are nominal. Contact Unilock for more information.



APPLICATIONS



APPEARANCE

Edge Detail - Zero
 Surface Texture - Textured
 Joint Spacing - 3 mm

TECHNOLOGIES

CLASSIC
 Budget-friendly traditional product mix

CLASSIC COAT

Factory-sealed to protect surface texture and color

TECHNICAL INFORMATION

Conforms to ASTM C 936
 Eligible for LEED v4.1 credits

LAYING PATTERNS



Westport Fixed
Random_A

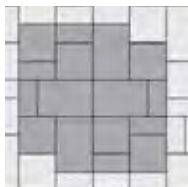

Westport Fixed
Random_B

		RECTANGLE	
Bundle Type		RANDOM	SINGLE
Plant Produced		ELKHORN	ELKHORN
Thickness (mm)		70 MM	70 MM

SQFT PER	Bundle	94.19	94.19
	Layer	11.77	11.77
	Section	-	-
	Stone	-	0.34

PER BUNDLE	Layers	8.00	8.00
	Sections	-	-

SOLDIER LNFT PER	SqFt	-	0.71
	Section	-	-
	Layer	-	8.33
	Bundle	-	66.67

SAILOR LNFT PER	SqFt	1.24	1.42
	Section	-	-
	Layer	14.57	16.67
	Bundle	116.56	133.33

UNITS PER	SqFt	-	2.97
	Section	-	-
	Bundle	160.00	280.00

LBS PER	Layer	372	361
	Section	-	-
	Bundle	2,976	2,884

COLORS	Reflectance	Stock	Stock
Charcoal	SR n/a SRI n/a	-	✓
Granite	SR n/a SRI n/a	✓	-
River	SR n/a SRI n/a	✓	-
Sierra	SR n/a SRI n/a	✓	-

Random Bundle



LARGE RECTANGLE
 254x 380 x 70mm
 10 x 15 x 2 ¾"
 32 units/Bundle
 1.01 Sq.Ft./Stone



SQUARE
 254 x 254 x 70mm
 10 x 10 x 2 ¾"
 56 units/Bundle
 .67 Sq.Ft./Stone



RECTANGLE
 127x 254 x 70mm
 5 x 10 x 2 ¾"
 72 units/Bundle
 .34 Sq.Ft./Stone

Single Unit



RECTANGLE
 127x 254 x 70mm
 5 x 10 x 2 ¾"
 280 units/Bundle
 .34 Sq.Ft./Stone

Notes: **SOLD IN FULL BUNDLES ONLY** and is produced and sold on a required, refundable skid. **Important:** A urethane rubber paver mat must be used to prevent scuffing when compacting on textured surfaces. Please refer to the Sealer Best Practices on page 84 and Important Notes on page 86. All measurements are nominal. Contact Unilock for more information.



APPLICATIONS



CROSS SECTIONS

Cross Sections are available on Unilock's Contractor web site under Products: contractor.unilock.com

APPEARANCE

Surface Texture - Standard

TECHNOLOGIES

CLASSIC™

Budget-friendly traditional product mix

ANTIQUED™

Distressed, timeworn finish

TECHNICAL INFORMATION

Conforms to ASTM C 1372

Eligible for LEED v4.1 credits

	TAPERED	STANDARD
Bundle Type	SINGLE	SINGLE
Plant Produced		
Thickness (mm)	100 MM	100 MM

FCFT PER	Bundle	36.00	32.00
	Layer	6.00	5.33
	Stone	0.25	0.33

PER BUNDLE	Layers	6.00	6.00
	Sections	-	4.00

LNFT PER	Bundle	108.00	96.00
	Unit	0.75	1.00

UNITS PER	SqFt	4.00	3.00
	Section	-	24.00
	Bundle	144.00	96.00

LBS PER	Layer	488	491
	Section	-	736
	Bundle	2,930	2,944

COLORS		Stock	Stock
Granite	SR.n/a SRI n/a	✓	-
Limestone	SR.n/a SRI n/a	-	✓
Sandstone	SR.n/a SRI n/a	✓	✓
Sierra	SR.n/a SRI n/a	✓	✓



ROUND



SQUARE

SUNSET FIRE PIT KITS - Located on page 75

Single Units



TAPERED

229 x 100 x 200mm
9 x 3 7/8 x 7 7/8"
144 units/Bundle
.25 Fc.Ft./Stone



STANDARD

300 x 100 x 200mm
11 7/8 x 3 7/8 x 7 7/8"
96 units/Bundle
.33 Fc.Ft./Stone

Notes: **SMALL TAPERED UNITS ARE SOLD IN FULL BUNDLES ONLY.** Maximum height is 24" (under optimum conditions). *Based on 12" deep wall coverage = 21.4 sqft per bundle. Based on an 8" deep wall coverage = 32 sqft per bundle. Ledgestone™, Brussels Block® XL or 6" x 12" Fullnose complement as a possible coping unit. All measurements are nominal. Contact Unilock for more information.



APPLICATIONS



CROSS SECTIONS

Cross Sections are available on Unilock's Contractor web site under Products: contractor.unilock.com

APPEARANCE

Surface Texture - Standard

TECHNOLOGIES

CLASSIC™

Budget-friendly traditional product mix

TECHNICAL INFORMATION

Conforms to ASTM C 1372

Eligible for LEED v4.1 credits

	TIE-BACK	1/2 COPING	CORNER 45°
Bundle Type	SINGLE	SINGLE	SINGLE
Plant Produced	GORMLEY	GORMLEY	GORMLEY
Thickness (mm)	300MM	300MM	300MM

FCFT PER	Bundle	2.00	3.00	7.04
	Layer	2.00	3.00	7.04
	Stone	2.00	3.00	7.04

PER BUNDLE	Layers	1.00	1.00	1.00
	Sections	-	-	-

LNFT PER	Bundle	-	3.00	-
	Unit	-	3.00	-

UNITS PER	SqFt	0.50	0.33	0.14
	Section	-	-	-
	Bundle	1.00	1.00	1.00

LBS PER	Layer	1,660	800	1,480
	Section	-	-	-
	Bundle	1,660	800	1,480

COLORS		Stock	Stock	Stock
Natural	SR n/a SRI n/a	SO	SO	SO



Single Units



TIE-BACK
1830 x 300 x 600mm
72 x 11 7/8 x 23 5/8"
1 unit/Bundle
2.00 Fc.Ft./Stone



1/2 COPING
915 x 300 x 600mm
36 x 11 7/8 x 23 5/8"
1 unit/Bundle
3.00 Fc.Ft./Stone



CORNER 45°
1520 x 300 x 600mm
59 7/8 x 11 7/8 x 23 5/8"
1 unit/Bundle
7.04 Fc.Ft./Stone

Notes: *Special Order - Lead time is required, minimum quantities apply. SOLD IN FULL BUNDLES ONLY. Closed-end coping units are closed on both ends so that they may be used as left or right units. Tie-back units are reinforced with steel. 1/2 Standard units are slightly tapered and can be used to create a 45 foot radius. Refer to terms and conditions for placement rates. Unilock, through Risi Stone® Systems International, can provide preliminary site engineering for most commercial projects. Soils information, site drawings, and loading requirements are some of the information details required in order to provide this preliminary site engineering. All measurements are nominal. Contact Unilock for more information.



APPLICATIONS



CROSS SECTIONS

Cross Sections are available on Unilock's Contractor web site under Products: contractor.unilock.com

APPEARANCE

Surface Texture - Split

TECHNOLOGIES

CLASSIC™

Budget-friendly traditional product mix

ANTIQUED™

Distressed, timeworn finish

TECHNICAL INFORMATION

Conforms to ASTM C 1372

Eligible for LEED v4.1 credits

		CORNER	COPING TAPERED
Bundle Type	RANDOM	SINGLE	SINGLE
Plant Produced	CHICAGO	CHICAGO	CHICAGO
Thickness (mm)	150 MM	150 MM	75 MM

FCFT PER				
	Bundle	31.25	20.83	18.74
	Layer	6.25	4.17	2.34
	Stone	-	0.52	0.26

PER BUNDLE				
	Layers	5.00	5.00	8.00
	Sections	4.00	4.00	3.00

LNFT PER				
	Bundle	62.30	41.60	66.00
	Unit	1.04	1.04	0.92

UNITS PER				
	SqFt	-	1.92	3.84
	Section	15.00	10.00	24.00
	Bundle	60.00	40.00	72.00

LBS PER				
	Layer	608	453	299
	Section	760	566	797
	Bundle	3,040	2,264	2,392

COLORS		Stock	Stock	Stock
Granite	SR.n/a SRI n/a	✓	✓	✓
River	SR.n/a SRI n/a	✓	✓	✓
Sandstone	SR.n/a SRI n/a	✓	✓	✓
Sierra	SR.n/a SRI n/a	✓	✓	✓

Random Bundle				Single Units		
	LARGE TAPERED 380 x 150 x 230mm 15 x 5 7/8 x 9" 20 units/Bundle .63 Fc.Ft./Stone	MEDIUM TAPERED 320 x 150 x 230mm 12 5/8 x 5 7/8 x 9" 20 units/Bundle .52 Fc.Ft./Stone	SMALL TAPERED 250 x 150 x 230mm 9 7/8 x 5 7/8 x 9" 20 units/Bundle .42 Fc.Ft./Stone		CORNER 320 x 150 x 230mm 12 5/8 x 5 7/8 x 9" 40 units/Bundle .52 Sq.Ft./Stone	COPING TAPERED 320 x 75 x 300mm 12 5/8 x 3 x 11 7/8" 72 units/Bundle .26 Sq.Ft./Stone

Notes: 6" random wall bundles have convertible large units that can be used for corners or ending seat walls. End caps not sold separately. **Quarry tubing is only added to orders if requested.** Ledgestone™, Olde Quarry™ coping, Brussels Block® XL, Brussels Fullnose™ or 6" x 12" Fullnose complement as a possible coping. All measurements are nominal. Contact Unilock for more information.



APPLICATIONS



CROSS SECTIONS

Cross Sections are available on Unilock's Contractor web site under Products:

contractor.unilock.com

APPEARANCE

Surface Texture - Standard

TECHNOLOGIES

CLASSIC™

Budget-friendly traditional product mix

TECHNICAL INFORMATION

Conforms to ASTM C 1372

Eligible for LEED v4.1 credits

		PILLAR UNIT	
Bundle Type		RANDOM	SINGLE
Plant Produced		CHICAGO	CHICAGO
Thickness (mm)		100 MM	100 MM

FCFT PER	Bundle	31.91	29.97
	Layer	10.64	9.99
	Stone	-	0.33

PER BUNDLE	Layers	3.00	3.00
	Sections	-	3.00

LNFT PER	Bundle	94.46	-
	Unit	1.50	-

UNITS PER	SqFt	-	3.00
	Section	-	30.00
	Bundle	63.00	90.00

LBS PER	Layer	948	890
	Section	-	890
	Bundle	2,845	2,670

COLORS		Stock	Stock
Granite	SR.n/a SRI n/a	✓	✓
Graphite	SR.n/a SRI n/a	✓	✓
River	SR.n/a SRI n/a	✓	✓
Sierra	SR.n/a SRI n/a	✓	✓

Lineo spacers are used to provide shadow effect during installation and are provided with your Lineo product. 1 Package = 144 Spacers / 68 T's

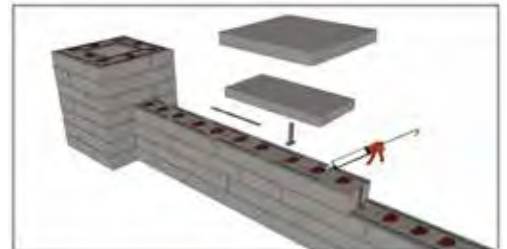
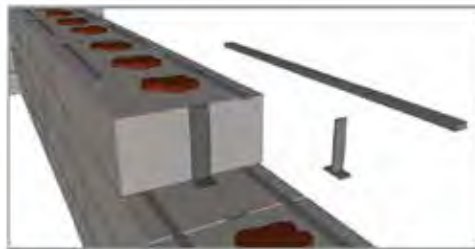

Random Bundle	XL RECTANGLE	LARGE RECTANGLE	RECTANGLE	SMALL RECTANGLE	Single Unit	PILLAR UNIT
	600 x 100 x 200mm	500 x 100 x 200mm	400 x 100 x 200mm	300 x 100 x 200mm		300 x 100 x 200mm
	23 5/8 x 3 3/8 x 7 7/8	19 3/4 x 3 3/8 x 7 7/8	15 3/4 x 3 3/8 x 7 7/8	11 7/8 x 3 3/8 x 7 7/8		11 7/8 x 3 3/8 x 7 7/8
	18 units/Bundle	15 units/Bundle	15 units/Bundle	15 units/Bundle		90 units/Bundle
	.33 Fc.Ft./Stone	.33 Fc.Ft./Stone	.55 Fc.Ft./Stone	.44 Fc.Ft./Stone		.33 Fc.Ft./Stone

Notes: **SOLD IN FULL BUNDLES ONLY** and is produced on a required, refundable skid. Lineo spacers are shipped with random wall bundles to create even spacing between units. LedgeStone™, Unilock Natural Stone 6" x 12" Fullnose complement as possible coping options. All measurements are nominal. Contact Unilock for more information.



APPLICATIONS



CROSS SECTIONS

Cross Sections are available on Unilock's Contractor web site under Products: contractor.unilock.com

APPEARANCE

Surface Texture - Standard

TECHNOLOGIES

CLASSIC™

Budget-friendly traditional product mix

ANTIQUED™

Distressed, timeworn finish

TECHNICAL INFORMATION

Conforms to ASTM C 1372

Eligible for LEED v4.1 credits

		CORNER	COPING
Bundle Type	RANDOM	SINGLE	SINGLE
Plant Produced	WISCONSIN	CHICAGO	CHICAGO
Thickness (mm)	114 MM	114 MM	75 MM

FCFT PER	Bundle	33.75	30.89	24.00
	Layer	5.63	6.18	3.00
	Stone	0.38	0.39	0.25





PER BUNDLE	Layers	6.00	5.00	8.00
	Sections	5.00	4.00	4.00

LNFT PER	Bundle	90.00	82.40	96.00
	Unit	1.00	1.03	1.00

UNITS PER	SqFt	2.67	2.59	4.00
	Section	18.00	20.00	24.00
	Bundle	90.00	80.00	96.00

LBS PER	Layer	521	630	380
	Section	625	788	760
	Bundle	3,125	3,150	3,039

COLORS		Stock	Stock	Stock
Granite	SR.n/a SRI n/a	✓	✓	✓
River	SR.n/a SRI n/a	✓	✓	✓
Sandstone	SR.n/a SRI n/a	✓	✓	✓
Sierra	SR.n/a SRI n/a	✓	✓	✓

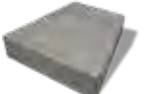
Random Bundle				Single Units		
	15"	12"	9"		CORNER	COPING TAPERED
	380 x 114 x 230mm 15 x 4 1/2 x 9" 30 units/Bundle .47 Fc.Ft./Stone	305 x 114 x 230mm 12 x 4 1/2 x 9" 30 units/Bundle .38 Fc.Ft./Stone	230 x 114 x 230mm 9 x 4 1/2 x 9" 30 units/Bundle .28 Fc.Ft./Stone		300 x 114 x 230mm 11 7/8 x 4 1/2 x 9" 80 units/Bundle .39 Fc.Ft./Stone	305 x 75 x 305mm 12 x 3 x 12" 96 units/Bundle .25 Fc.Ft./Stone
	* 32 Corner Units/Bundle					

Notes: Structural retaining walls greater than 2' high require professional engineering. Quarry tubing is added to orders when requested. Tubing may be used to set back walls. Ledgestone™, Olde Quarry™ Coping, Brussels Block™ XL, Brussels Fullnose™ or 6" x 12" Fullnose complement as a possible coping. All measurements are nominal. Contact Unilock for more information.



APPLICATIONS



CROSS SECTIONS

Cross Sections are available on Unilock's Contractor web site under Products: contractor.unilock.com

APPEARANCE

Surface Texture - Standard

TECHNOLOGIES

CLASSIC™

Budget-friendly traditional product mix

TECHNICAL INFORMATION

Conforms to ASTM C 1372

Eligible for LEED v4.1 credits

		CORNER
Bundle Type	RANDOM	SINGLE
Plant Produced	CHICAGO / ELKHORN	CHICAGO / ELKHORN
Thickness (mm)	100 MM	100 MM

FCFT PER	Bundle	33.75	22.63
	Layer	-	-
	Stone	5.63	7.54

PER BUNDLE	Layers	6.00	3.00
	Sections	5.00	-

LNFT PER	Bundle	-	22.50
	Unit	-	0.38

UNITS PER	SqFt	2.65	3.00
	Section	60.00	-
	Bundle	90.00	60.00

LBS PER	Layer	530	778
	Section	6.36	-
	Bundle	3,180	2,335

COLORS		Stock	Stock
Fieldstone	SR.n/a SRI n/a	✓	✓
Granite	SR.n/a SRI n/a	✓	✓
Sierra	SR.n/a SRI n/a	✓	✓

Random Bundle



15" UNIT
380 x 114 x 230mm
15 x 4 1/2 x 9"
30 units/Bundle
.33 Fc.Ft./Stone



12" UNIT
305 x 114 x 230mm
12 x 4 1/2 x 9"
30 units/Bundle
.33 Fc.Ft./Stone



9" UNIT
230 x 114 x 230mm
9 x 4 1/2 x 9"
30 units/Bundle
.55 Fc.Ft./Stone

Single Unit



CORNER
305 x 114 x 230mm
12 x 4 1/2 x 9"
60 units/Bundle
.33 Fc.Ft./Stone

Notes: Structural retaining walls greater than 2' high require professional engineering. Connector units provided with every bundle upon request. Use plastic connectors on set-back walls. **Quarry tubing is added to orders when requested. Tubing may be used to set back walls.** LedgeStone™, Olde Quarry™ Coping, Brussels Block™ XL, Brussels Fullnose™ or 6" x 12" Fullnose complement as a possible coping. All measurements are nominal. Contact Unilock for more information.



APPLICATIONS



CROSS SECTIONS

Cross Sections are available on Unilock's Contractor web site under Products: contractor.unilock.com

APPEARANCE

Edge Detail - n/a
Surface Texture - Split

TECHNOLOGIES

CLASSIC™

Budget-friendly traditional product mix

TECHNICAL INFORMATION

Conforms to ASTM C 1372
Eligible for LEED v4.1 credits

	CORNER	XL UNIT
Bundle Type	DOUBLE	SINGLE
Plant Produced	CHICAGO	CHICAGO
Thickness (mm)	150 MM	150 MM

FCFT PER	Bundle	30.01	21.33
	Layer	10.00	5.33
	Stone	1.67	0.67

PER BUNDLE	Layers	3.00	4.00
	Sections	6.00	-

LNFT PER	Bundle	-	42.67
	Unit	-	1.33

UNITS PER	SqFt	0.60	1.50
	Section	3.00	-
	Bundle	18.00	32.00

LBS PER	Layer	547	629
	Section	274	-
	Bundle	1,641	2,514

COLORS		Stock	Stock
Granite	SR.n/a SRI n/a	✓	✓
Nevada	SR.n/a SRI n/a	✓	✓
Sierra	SR.n/a SRI n/a	✓	✓

Single Units



CORNER
200 x 150 x 300mm
7 7/8 x 5 7/8 x 11 7/8"
18 Double units/Bundle
36 Single units/Bundle
1.67 Fc.Ft./Stone



XL UNIT
400 x 150 x 300mm
15 3/4 x 5 7/8 x 11 7/8"
32 Single units/Bundle
.67 Fc.Ft./Stone

Notes: **XL UNITS ARE SOLD IN FULL BUNDLES ONLY.** Corner and XL Units are produced and sold on a required, refundable skid. Maximum height - 36" (under optimum conditions). Higher walls can be achieved using geogrid reinforcement. The set back on Pisa wall is 3/4" every course or 1 1/2" every 2 courses. Retaining wall engineering software is also available free of charge at www.unilock.com. Walls greater than 4' in height require professional engineering. All measurements are nominal. Contact Unilock for more information.



APPLICATIONS



APPEARANCE

Edge Detail - n/a

Surface Texture - Standard

CROSS SECTIONS

Cross Sections are available on Unilock's

Contractor web site under Products:

contractor.unilock.com

TECHNOLOGIES

CLASSIC™

Budget-friendly traditional product mix

TECHNICAL INFORMATION

Conforms to ASTM C 1372

Eligible for LEED v4.1 credits

	CORNER	XL TAPERED	COPING BUNDLE
Bundle Type	SINGLE	SINGLE	MULTI COMPONENT
Plant Produced	CHICAGO	CHICAGO	CHICAGO
Thickness (mm)	150 MM	150 MM	75 MM

FCFT PER	Bundle	46.52	20.67	15.50
	Layer	11.63	5.17	1.94
	Stone	0.97	0.65	0.32





PER BUNDLE	Layers	4.00	4.00	8.00
	Sections	6.00	-	3.00

LNFT PER	Bundle	-	-	62.99
	Unit	-	-	1.31

UNITS PER	SqFt	1.03	1.55	3.10
	Section	8.00	-	16.00
	Bundle	48.00	32.00	48.00

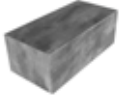
LBS PER	Layer	695	627	282
	Section	463	-	752
	Bundle	2,780	2,508	2,256

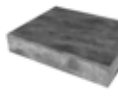
COLORS	Reflectance	Stock	Stock	Stock
Fieldstone	SR n/a SRI n/a	✓	✓	✓
Granite	SR n/a SRI n/a	✓	✓	✓

Single Units			Coping Bundle		
	<p>CORNER 400 X 150 X 200MM 15 3/4 X 5 7/8 X 7 7/8" 48 Units/Bundle 0.97 Fc.Ft./Stone</p>	<p>XL TAPERED 400 X 150 X 300MM 15 3/4 X 5 7/8 X 11 7/8" 32 Units/Bundle 0.65 Fc.Ft./Stone</p>		<p>COPING 400 X 75 X 300MM 15 3/4 X 3 X 11 7/8" 24 Units/Bundle 0.32 Fc.Ft./Stone</p>	<p>CLOSED-END 400 X 75 X 300MM 15 3/4 X 3 X 11 7/8" 24 Units/Bundle 0.32 Fc.Ft./Stone</p>

Notes: Coping units can be used to construct steps. Retaining wall engineering software is also available free of charge at www.unilock.com. All measurements are nominal. Contact Unilock for more information.



APPLICATIONS



CROSS SECTIONS

Cross Sections are available on Unilock's Contractor web site under Products:

contractor.unilock.com

APPEARANCE

Edge Detail - n/a

Surface Texture - Smooth

TECHNOLOGIES

CLASSIC™

Budget-friendly traditional product mix

TECHNICAL INFORMATION

Conforms to ASTM C 1372

Eligible for LEED v4.1 credits

	STANDARD	COPING
Bundle Type	SINGLE	SINGLE
Plant Produced	CHICAGO	CHICAGO
Thickness (mm)	180 MM	180 MM

FCFT PER	Bundle	23.25	23.25
	Layer	7.75	7.75
	Stone	1.94	1.94

PER BUNDLE	Layers	3.00	3.00
	Sections	-	-

LNFT PER	Bundle	39.37	39.37
	Unit	3.28	3.28

UNITS PER	SqFt	0.52	0.52
	Section	-	-
	Bundle	12.00	12.00

LBS PER	Layer	1,036	1,008
	Section	-	-
	Bundle	3,108	3,024

COLORS		Stock	Stock
Fieldstone	SR n/a SRI n/a	✓	✓
Granite	SR n/a SRI n/a	✓	✓
Sierra	SR n/a SRI n/a	✓	✓

Single Units



STANDARD
1000 x 180 x 290mm
39 3/8 x 7 x 11 1/2"
12 units/Bundle
1.94 Fc.Ft./Stone



COPING
1000 x 180 x 290mm
39 3/8 x 7 x 11 1/2"
12 units/Bundle
1.94 Fc.Ft./Stone

Notes: **SOLD IN FULL BUNDLES ONLY** and is produced and sold on a required, refundable skid. Coping units can be used to construct steps. Retaining wall engineering software is also available free of charge at www.unilock.com. All measurements are nominal. Contact Unilock for more information.



APPLICATIONS



APPEARANCE

Edge Detail - n/a

Surface Texture - Split

CROSS SECTIONS

Cross Sections are available on Unilock's Contractor web site under Products:

contractor.unilock.com

TECHNOLOGIES

CLASSIC™

Budget-friendly traditional product mix

TECHNICAL INFORMATION

Conforms to ASTM C 1372

Eligible for LEED v4.1 credits

	CORNER 90	CORNER 45	STANDARD	STANDARD 925	COPING
Bundle Type	SINGLE	SINGLE	SINGLE	SINGLE	SINGLE
Plant Produced	CHICAGO	CHICAGO	CHICAGO	CHICAGO	CHICAGO
Thickness (mm)	185MM	185MM	185MM	185MM	185MM

FCFT PER	Bundle	17.19	13.50	12.00	6.00	12.00
	Layer	5.73	4.50	4.00	2.00	4.00
	Stone	2.87	2.25	2.00	2.00	2.00

PER BUNDLE	Layers	3.00	3.00	3.00	3.00	3.00
	Sections	-	-	-	-	6.00

LNFT PER	Bundle	-	-	19.50	9.75	19.50
	Unit	-	-	3.25	3.25	3.25

UNITS PER	SqFt	0.35	0.44	0.50	0.50	0.50
	Section	-	-	-	-	1.00
	Bundle	6.00	6.00	6.00	3.00	6.00

LBS PER	Layer	954	790	926	872	919
	Section	-	-	-	-	459
	Bundle	2,862	2,370	2,778	2,617	2,756

COLORS			Stock	Stock	Stock	Stock	Stock
Granite	SR n/a	SRI n/a	-	-	-	-	✓
Nevada	SR n/a	SRI n/a	SO	SO	SO	SO	✓
Sierra	SR n/a	SRI n/a	SO	SO	SO	SO	✓

Single Units					
	CORNER 90°	CORNER 45°	STANDARD	STANDARD 925	COPING
	925 x 185 x 500mm	925 x 185 x 500mm	1000 x 185 x 500mm	1000 x 185 x 925mm	1000 x 185 x 500mm
	36 1/2 x 7 3/8 x 19 3/4"	36 1/2 x 7 3/8 x 19 3/4"	39 3/8 x 7 3/8 x 19 3/4"	39 3/8 x 7 3/8 x 36 1/2"	39 3/8 x 7 3/8 x 19 3/4"
	6 units/Bundle	6 units/Bundle	6 units/Bundle	3 units/Bundle	6 units/Bundle
	2.87 Fc.Ft./Stone	2.25 Fc.Ft./Stone	2.00 Fc.Ft./Stone	2.00 Fc.Ft./Stone	2.00 Fc.Ft./Stone

Notes: For Special Order units - Lead time is required, minimum quantities apply. SOLD IN FULL BUNDLES ONLY and is sold on a required, refundable skid. Coping units can be sold individually to construct steps. Retaining wall engineering software is also available free of charge at www.unilock.com. All measurements are nominal. Contact Unilock for more information.



	48" STEP
Bundle Type	SINGLE
Plant Produced	GORMLEY
Thickness (mm)	180 MM

FCFT PER	Bundle	13.95
	Layer	4.65
	Stone	2.33

PER BUNDLE	Layers	3.00
	Sections	-

LNFT PER	Bundle	24.00
	Unit	4.00

UNITS PER	SqFt	0.43
	Section	-
	Bundle	6.00

LBS PER	Layer	1,081
	Section	-
	Bundle	3,242

COLORS		Stock
Dusk	SR.n/a SRI n/a	✓

APPLICATIONS



APPEARANCE

Edge Detail - n/a

Surface Texture - Standard

CROSS SECTIONS

Cross Sections are available on Unilock's Contractor web site under Products:

contractor.unilock.com

TECHNOLOGIES

CLASSIC™

Budget-friendly traditional product mix

TECHNICAL INFORMATION

Conforms to ASTM C 1372

Eligible for LEED v4.1 credits

Single Unit



48" STEP

1200 x 180 x 500mm

47 1/4 x 7 x 19 3/4"

6 units/Bundle

2.33 Fc.Ft./Stone

Notes: **SOLD IN FULL BUNDLES ONLY** and is sold on a required, refundable skid. All measurements are nominal. Contact Unilock for more information.

U-Cara® Multi-Face Wall System



APPLICATIONS



APPEARANCE

Edge Detail - n/a

Surface Texture - Smooth, Standard, Series

Exposed, Umbriano® Mottled & Pitched

TECHNOLOGIES

ENDURACOLOR™

Refined surface and long-lasting color

COLORFUSION™ (UMBRIANO)

Subtly mottled colored finish

TECHNICAL INFORMATION

Conforms to ASTM C 1372

Eligible for LEED v4.1 credits



Download the U-Cara Modular Fireplace Installation Guide.

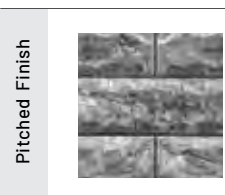
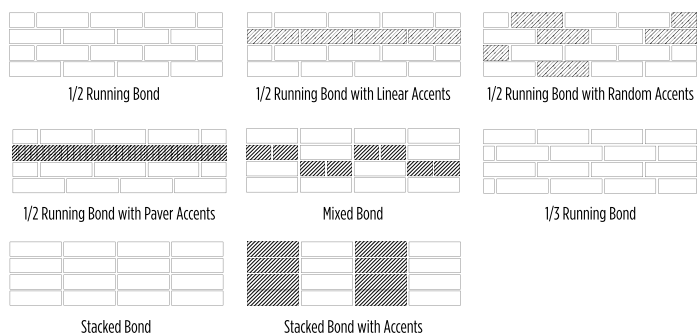

U-Cara® Multi-Face Wall System

Fascia Panels	Standard Smooth	Closed-End Smooth	Standard Umbriano	Closed-End Umbriano	3" Series	Standard Pitched	Closed-End Pitched
Bundle Type	SINGLE	MULTI	SINGLE	MULTI	SINGLE	SINGLE	MULTI
Plant Produced	CHICAGO	CHICAGO	MARENGO	MARENGO	CHICAGO	MARENGO	MARENGO
Thickness (mm)	150 MM	150 MM	150 MM	150 MM	71 MM	150 MM	150 MM

FCFT PER	Bundle	61.52	54.18	61.52	54.18	59.32	61.52	54.18
	Crate	-	-	-	-	-	-	-
	Section	10.25	9.03	10.25	9.03	9.89	10.25	9.03
	Stone	0.73	1.29	0.73	1.29	0.18	0.73	1.29

PER BUNDLE	Layers	6.00	6.00	6.00	6.00	6.00	6.00	6.00
	Sections	-	-	-	-	-	-	-

LNFT PER	Bundle	129.50	104.86	129.50	107.94	-	129.50	107.94
	Unit	1.54	2.50	1.54	2.57	-	1.54	2.57

UNITS PER	SqFt	1.37	0.78	1.37	0.78	5.66	1.37	0.78
	Section	-	-	-	-	-	-	-
	Crate	-	-	-	-	-	-	-
	Bundle	84.00	42.00	84.00	42.00	336.00	84.00	42.00

LBS PER	Layer	275	207	344	207	250	317	236
	Section	-	-	-	-	-	-	-
	Crate	-	-	-	-	-	-	-
	Bundle	1,648	1,241	2,067	1,240	1,501	1,904	1,416

COLORS		Stock	Stock	Stock	Stock	Stock	Stock	Stock
Bavarian		✓	✓	-	-	-	✓	✓
Champagne NEW		✓	✓	-	-	-	-	-
Dark Charcoal		✓	✓	-	-	-	-	-
Fossil		-	-	-	-	-	✓	✓
French Grey		-	-	✓	✓	-	-	-
Granite Fusion		✓	✓	-	-	-	✓	✓
Opal Blend		✓	✓	-	-	-	-	-
Onyx Black		-	-	-	-	✓	-	-
Summer Wheat		-	-	✓	✓	-	-	-

Fascia Panels		STANDARD $5\frac{7}{8} \times 18\frac{3}{8} \times 2\frac{3}{8}$ " 150 x 466 x 60mm 84 units/Bundle .73 Fc.Ft./Stone		3" SERIES $2\frac{7}{8} \times 9 \times 2\frac{3}{8}$ " 71 x 231 x 60mm 336 units/Bundle .18 Fc.Ft./Stone	Available in Onyx Black only
	Closed-End Bundle		STANDARD HALF $5\frac{7}{8} \times 9\frac{1}{4} \times 2\frac{3}{8}$ " 150 x 233 x 60mm 42 units/Bundle 1.29 Fc.Ft./Stone		CLOSED-END $5\frac{7}{8} \times 20\frac{7}{8} \times 2\frac{3}{8}$ " 150 x 530 x 60mm 42 units/Bundle 1.29 Fc.Ft./Stone 24 Rights & 18 Lefts

Notes: **SOLD IN FULL BUNDLES ONLY** and is produced and sold on a required, refundable skid. **Important:** A urethane rubber paver mat must be used to prevent scuffing when compacting. All measurements are nominal. Contact Unilock for more information.

U-Cara® Multi-Face Wall System



U-CARA RETAINING WALL GEOGRID SECTION

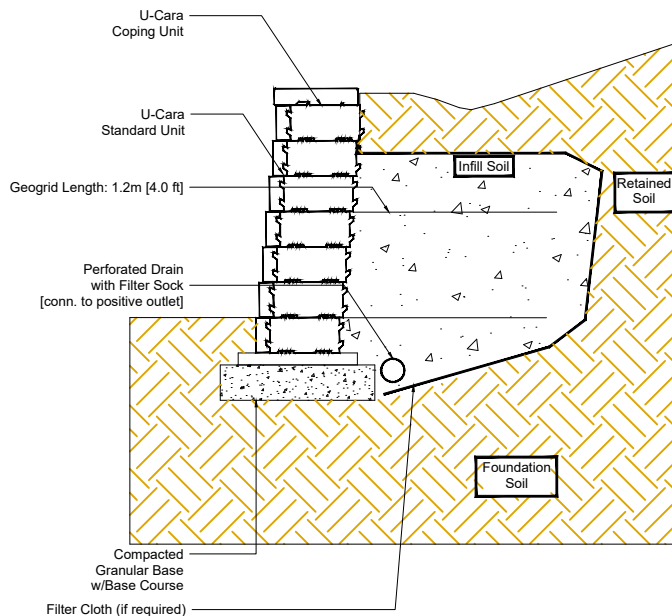

APPLICATIONS



ENDURACOLOR™
Refined surface and long-lasting color

COLORFUSION™ (UMBRIANO)
Subtly mottled colored finish

TECHNICAL INFORMATION
Conforms to ASTM C 1372
Eligible for LEED v4.1 credits

CROSS SECTIONS

All Cross Sections are available on Unilock's Contractor web site under Products:

contractor.unilock.com

APPEARANCE

Edge Detail - n/a
Surface Texture - Smooth,
Standard, Series Exposed,
Umbriano® Mottled, Pitched &
Flamed

U-CARA®

CROSS SECTION

REF-Detail_U-Cara_Garden_Wall

Garden Wall - Max Height 15"

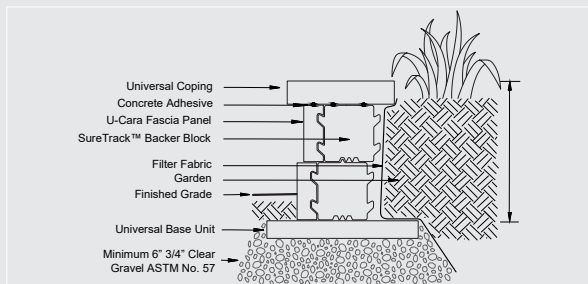

Notes:
This cross section is intended for preliminary design purposes only. Confirm site conditions and consult with a qualified design professional or installer prior to installation.

U-CARA®

CROSS SECTION

REF-Detail_U-Cara_Seal_Wall

Seal Wall - Max Height 21"

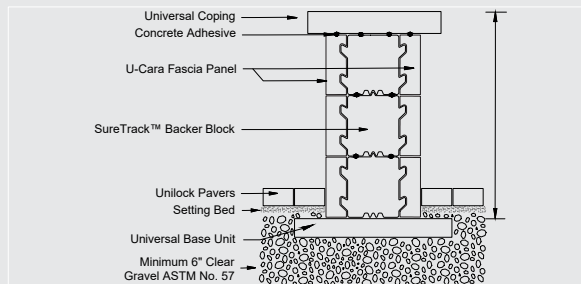

Notes:
This cross section is intended for preliminary design purposes only. Confirm site conditions and consult with a qualified design professional or installer prior to installation.

U-Cara® Multi-Face Wall System

Sure Track Components



CORNER BACKER
5 7/8 x 6 7/8 x 11 5/8"
150 x 175 x 294mm



LARGE BACKER
5 7/8 x 7 7/8 x 11 5/8"
150 x 200 x 294mm



STANDARD BACKER
5 7/8 x 7 7/8 x 5 7/8"
150 x 200 x 150mm

		LARGE/CORNER/ PILLAR BACKER	LARGE BACKER	STANDARD BACKER
Bundle Type		SINGLE	SINGLE	SINGLE
Plant Produced		CHICAGO	CHICAGO	CHICAGO
Thickness (mm)		150 MM	150 MM	150 MM
FCFT PER	Bundle	15.82	20.35	33.91
	Layer	3.96	6.78	11.30
	Stone	0.28	0.32	0.32
PER BUNDLE	Layers	4.00	3.00	3.00
	Sections	-	-	-
LNFT PER	Bundle	-	41.34	69.99
	Unit	-	0.66	0.67
UNITS PER	SqFt	3.54	3.10	3.10
	Section	-	-	-
	Bundle	56.00	63.00	105.00
LBS PER	Layer	521	922	819
	Section	-	-	-
	Bundle	2,085	2,766	2,458

Notes: **SOLD IN FULL BUNDLES ONLY** and is produced and sold on a required, refundable skid. **Important:** A urethane rubber paver mat must be used to prevent scuffing when compacting. All measurements are nominal. Contact Unilock for more information.

Recommended Base Unit



UNIVERSAL U-GRIP™ BASE
14 x 19 x 2 1/4"
355 x 482 x 55mm

Extra Components



**SURE TRACK
CORNER INSERT**
L = 2"
50mm

U-Cara® Modular System

The U-Cara Modular System offers a variety of aluminum frames that can be mixed and matched to construct vertical features like grill islands. Speak to your contractor to select a design and a U-Cara fascia panel finish to suit your project.

With the U-Cara Modular System you can build Grill Islands, Bars, Back splashes, Fire Places and Pillars.



Download the U-Cara Modular Fireplace Installation Guide.

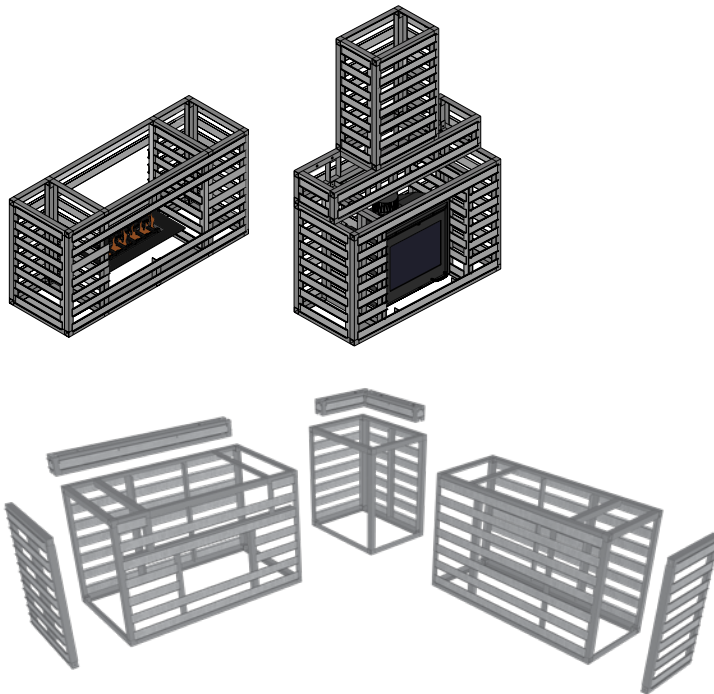

NO.	MODEL	DESCRIPTION
RS-UCARA000001	URS	UCARA 8" RAIL (10/PACK)
RS-UCARA000002	URS	ALIGNMENT BARS 39" (10/PACK)
RS-UCARA000005	UL-HCK	U-CARA HEIGHT CONVERSION
RS-UCARA000006	UL-HCK-OS	U-CARA HEIGHT CONVERSION KIT-OS
RS-UCARA000009	UL-FIR	U-CARA FIREPLACE
RS-UCARA000010	UL-FIR-M	U-CARA FIREPLACE MANTLE
RS-UCARA000014	UL-HCK-CC-OS	U-CARA HEIGHT CONV CORNER CAB
RS-UCARA000015	UL-HCK-CC	U-CARA HEIGHT CONVERSION CORNER CAB
RS-UCARA000016	UL-FIR-MW	U-CARA FIREPLACE MANTLE WIDE UNIT
RS-UCARA000017	UL-FIR-CH	U-CARA U-CARA FIREPLACE CHIMNEY UNIT
RS-UCARA000018	UL-FIR-CH-MW	U-CARA FIREPLACE CHIMNEY WIDE UNIT
RS-UCARA000019	UL-FIR-RTN	U-CARA FIREPLACE RETURN
RS-UCARA000020	UL-FIR-RTN-OS	U-CARA FIREPLACE RETURN OVERSIZED

NO.	MODEL	DESCRIPTION
RS-UCARA001000	UL-GC	UNIVERSAL GRILL CABINET
RS-UCARA002000	UL-BC	BASE CABINET
RS-UCARA003000	UL-CC	CORNER CABINET 27.5" X 27.5"
RS-UCARA003001	UL-CCOS	CORNER CABINET 27.5" X 36.5"
RS-UCARA003002	UL-CCBP	CORNER CABINET PANEL
RS-UCARA004000	UL-ECK	END CLAD KIT 27.5"
RS-UCARA004001	UL-ECKOS	END CLAD KIT 36.5"
RS-UCARA005000	UL-BS	BACKSPLASH GRILL/BASE UNIT 64.5"
RS-UCARA005001	UL-BSCC	BACKSPLASH CORNER CABINET
RS-UCARA005002	UL-BSCCOS	BACKSPLASH CORNER CABINET OS
RS-UCARA006000	UL-DD	UCS STNLSS DBL ACCESS DOORS 27"
RS-UCARA007000	UL-PU	PILLAR UNIT

U-Cara® Wall Mount System



The U-Cara Wall Mount System allows you to put the finishing touches on your project by cladding existing structures like unsightly exposed foundation areas or concrete steps with U-Cara fascia panels.



U-CARA ALIGNMENT BAR
RS-UCARA000002
39" LENGTH - SOLD IN PACKS OF 10 PIECES

U-CARA RAILS
RS-UCARA000001
8' LENGTH - SOLD IN PACKS OF 10 PIECES



APPLICATIONS



APPEARANCE

Edge Detail - n/a

Surface Texture - Standard / Smooth

TECHNOLOGIES

CLASSIC™

Budget-friendly traditional product mix

ENDURACOLOR™

Refined surface and long-lasting color

TECHNICAL INFORMATION

Conforms to ASTM C 1372

Eligible for LEED v4.1 credits

	UNIVERSAL U-GRIP BASE	UNIVERSAL COPING
Bundle Type	SINGLE	SINGLE
Plant Produced	CHICAGO	CHICAGO
Thickness (mm)	55 MM	70 MM

FCFT PER	Bundle	-	17.44
	Layer	-	2.18
	Stone	-	0.36

PER BUNDLE	Layers	9.00	8.00
	Sections	-	-

LNFT PER	Bundle	85.50	75.90
	Unit	1.58	1.58

UNITS PER	SqFt	-	2.75
	Section	-	-
	Bundle	54.00	48.00

LBS PER	Layer	280	361
	Section	-	-
	Bundle	2,524	2,890

COLORS		Stock	Stock
Buff (Coping)	SR.n/a SRI n/a	-	✓
Grey (Coping)	SR.n/a SRI n/a	-	✓
Natural (U-Grip)	SR.n/a SRI n/a	✓	-

Single Units



UNIVERSAL U-GRIP BASE

482 x 55 x 355mm
19 x 2 1/4 x 14"
54 units/Bundle



UNIVERSAL COPING

482 x 70 x 355mm
19 x 2 3/4 x 14"
48 units/Bundle
.36 Fc.Ft./Stone

Notes: **SOLD IN FULL BUNDLES ONLY** and is shipped on a required, refundable skid. Coping bundle includes 2 End units per Layer (1 Left & 1 Right). All measurements are nominal. Contact Unilock for more information.



APPLICATIONS



APPEARANCE

Edge Detail - n/a
Surface Texture - Textured

TECHNOLOGIES

REALA™
Cast from natural stone

TECHNICAL INFORMATION

Conforms to ASTM C 1776
Eligible for LEED v4.1 credits

	FULLNOSE COPING	STANDARD COPING	STANDARD CLOSED-END	LARGE COPING	LARGE CLOSED-END
Bundle Type	SINGLE	SINGLE	SINGLE	SINGLE	SINGLE
Plant Produced	CHICAGO	CHICAGO	CHICAGO	CHICAGO	CHICAGO
Thickness (mm)	60 MM	70 MM	70 MM	70 MM	70 MM

FCFT PER	Bundle	5.12	5.52	5.52	6.87	6.87
	Layer	0.39	1.38	1.38	1.72	1.72
	Stone	0.39	0.46	0.46	0.57	0.57

PER BUNDLE	Layers	13.00	4.00	4.00	4.00	4.00
	Sections	-	-	-	-	-

LNFT PER	Bundle	26.00	24.00	24.00	30.00	30.00
	Unit	2.00	2.00	2.00	2.50	2.50

UNITS PER	SqFt	2.54	2.18	2.18	1.75	1.75
	Section	-	-	-	-	-
	Bundle	13.00	12.00	12.00	12.00	12.00

LBS PER	Layer	56	193	199	282	279
	Section	-	-	-	-	-
	Bundle	723	772	796	1,128	1,116

COLORS		Stock	Stock	Stock	Stock	Stock
Buff	n/a	✓	✓	✓	✓	✓
Grey	n/a	✓	✓	✓	✓	✓



Notes: **SOLD IN FULL BUNDLES ONLY** and is produced and sold on a required, refundable skid. Coping is rock faced on the front and the back; Closed-end coping and steps are rock faced on three sides. All measurements are nominal. Contact Unilock for more information.



APPLICATIONS



APPEARANCE

Edge Detail - n/a

Surface Texture - Textured

TECHNOLOGIES

REALA™

Cast from natural stone

TECHNICAL INFORMATION

Conforms to ASTM C 1776

Eligible for LEED v4.1 credits

	30" STEP TREAD	48" STEP	72" STEP	24" PILLAR CAP	29" PILLAR CAP	21 1/2" FIRE PIT COPING
Bundle Type	SINGLE	SINGLE	SINGLE	SINGLE	SINGLE	SINGLE
Plant Produced	CHICAGO	MULTI-PLANT	MULTI-PLANT	CHICAGO	CHICAGO	CHICAGO
Thickness (mm)	70 MM	150 MM	150 MM	100 MM	100 MM	65 MM

FCFT PER	Bundle	6.87	5.91	8.86	3.28	-	-
	Layer	1.72	1.97	2.95	0.66	-	-
	Stone	0.57	1.97	2.95	0.66	-	-

PER BUNDLE	Layers	4.00	3.00	3.00	5.00	5.00	5.00
	Sections	-	-	-	-	-	-

LNFT PER	Bundle	30.00	12.00	18.00	10.04	-	-
	Unit	2.50	4.00	6.00	2.01	-	-

UNITS PER	SqFt	1.75	0.51	0.34	1.52	-	-
	Section	-	-	-	-	-	-
	Bundle	12.00	3.00	3.00	5.00	5.00	40.00

LBS PER	Layer	262	556	813	159	206	338
	Section	-	-	-	-	-	-
	Bundle	1,049	1,669	2,439	795	1,030	1,688

COLORS		Stock	Stock	Stock	Stock	Stock	Stock
Buff	n/a	✓	✓	✓	✓	✓	✓
Grey	n/a	✓	✓	✓	✓	✓	✓



Notes: **SOLD IN FULL BUNDLES ONLY** and is produced and sold on a required, refundable skid. Coping is rock faced on the front and the back; Closed-end coping and steps are rock faced on three sides. All measurements are nominal. Contact Unilock for more information.



APPLICATIONS



APPEARANCE

Edge Detail - Zero
 Surface Texture - Smooth
 Joint Spacing - 2mm

TECHNOLOGIES

CLASSIC™

Budget-friendly traditional product mix

ANTIQUED™

Distressed, timeworn finish

TECHNICAL INFORMATION

Conforms to ASTM C 936
 Eligible for LEED v4.1 credits

	FULLNOSE
Bundle Type	SINGLE
Plant Produced	CHICAGO
Thickness (mm)	60 MM

FCFT PER	Bundle	-
	Layer	-
	Stone	-

PER BUNDLE	Layers	8.00
	Sections	4.00

LNFT PER	Bundle	130.00
	Unit	0.50

UNITS PER	SqFt	-
	Section	658.00
	Bundle	260.00

LBS PER	Layer	365
	Section	731
	Bundle	2,924

COLORS		Stock
Charcoal	SR..12 SRI 9	✓
Sandstone	SR. .41 SRI 46	✓
Sierra	SR. n/a SRI n/a	✓

Single Unit



BRUSSELS FULLNOSE

152.4 x 304.8 x 60mm
 6 x 12 x 2 3/8"
 260 units/Bundle

Notes: Units can be adhered to pool edge using Unilock Concrete Adhesive, or with mortar. Always observe proper construction techniques when adhering pavers to a surface. Consult your local pool contractors for installation specifics.



APPLICATIONS



APPEARANCE

Edge Detail - Zero
 Surface Texture - Smooth
 Joint Spacing - 2mm

TECHNOLOGIES

CLASSIC™
 Budget-friendly traditional product mix

TECHNICAL INFORMATION

Conforms to ASTM C 936
 Eligible for LEED v4.1 credits

	FULLNOSE EDGER SMOOTH CLASSIC
Bundle Type	SINGLE
Plant Produced	MULTI-PLANT
Thickness (mm)	60 MM

FCFT PER	Bundle	-
	Layer	-
	Stone	-

PER BUNDLE	Layers	4.00
	Sections	4.00

LNFT PER	Bundle	96.00
	Unit	0.50

UNITS PER	SqFt	-
	Section	48.00
	Bundle	192.00

LBS PER	Layer	734
	Section	734
	Bundle	2,938

COLORS		Stock
Charcoal	SR. n/a SRI n/a	✓
Sandstone	SR. n/a SRI n/a	✓
Sierra	SR. n/a SRI n/a	✓

Single Unit



FULLNOSE EDGER
 150 x 300 x 60mm
 5 7/8 x 11 7/8 x 2 3/8"
 192 units/Bundle

Notes: **SOLD IN FULL BUNDLES ONLY** and is produced and sold on a required, refundable skid. Units can be adhered to pool edge using Unilock Concrete Adhesive, or with mortar. Always observe proper construction techniques when adhering pavers to a surface. Consult your local pool contractors for installation specifics.



APPLICATIONS



APPEARANCE

Edge Detail - n/a
 Surface Texture - Exposed
 Joint Spacing - n/a

TECHNOLOGIES

ENDURACOLOR™
 Refined surface and long-lasting color

TECHNICAL INFORMATION

Conforms to ASTM C 936
 Eligible for LEED v4.1 credits

	COPING	PILLAR CAP 28"
Bundle Type	SINGLE	SINGLE
Plant Produced		
Thickness (mm)	60 MM	76 MM

SQFT PER	Bundle	-	-
	Unit	-	-

FCFT PER	Bundle	-	-
	Layer	-	-
	Unit	-	-

LNFT PER	Bundle	42.00	-
	Unit	2.00	-

UNITS PER	Bundle	21.00	6.00
	SqFt	-	-

LBS PER	Unit	68	183
	Bundle	1,428	1,098

COLORS			Stock
Buff	SR n/a SRI n/a	✓	✓
Charcoal	SR n/a SRI n/a	✓	✓

Single Unit



COPING
 609 x 60mm x 355mm
 24 x 2 3/8 x 14"
 21 units/Bundle



Note: this unit is tapered at the top

PILLAR CAP
 711 x 76mm x 711mm
 28 x 3 x 28"
 6 units/Bundle

Notes: **SOLD IN FULL PALLET ONLY** and is shipped on a required, refundable skid. All measurements are nominal. Contact Unilock for more information.



APPLICATIONS



APPEARANCE

Edge Detail - Rounded
 Surface Texture - Umbriano Mottled
 Joint Spacing - 3mm

TECHNOLOGIES

ENDURACOLOR™

Refined surface and long-lasting color

EASYCLEAN™

Factory sealed to provide integral stain resistance

COLORFUSION™

Subtly mottled colored finish

TECHNICAL INFORMATION

Conforms to ASTM C 936
 Eligible for LEED v4.1 credits

	COPING CHAMFERED	COPING BULLNOSE
Bundle Type	SINGLE	SINGLE
Plant Produced	MULTI-PLANT	MULTI-PLANT
Thickness (mm)	60 MM	60 MM

FCFT PER	Bundle	-	-
	Layer	-	-
	Stone	-	-

PER BUNDLE	Layers	10.00	10.00
	Sections	-	-

LNFT PER	Unit	1.97	1.97
	Bundle	78.74	78.74

UNITS PER	SqFt	-	-
	Section	-	-
	Bundle	40.00	40.00

LBS PER	Layer	252	252
	Section	-	-
	Bundle	2,517	2,517

COLORS		Stock	Stock
French Grey	SR. .17 SRI 15	✓	✓
Midnight Sky	SR. .17 SRI 15	✓	✓
Summer Wheat	SR. .42 SRI 48	✓	✓
Winter Marvel	SR. .17 SRI 15	✓	✓

Single Unit



COPING CHAMFERED
 360 x 600 x 60mm
 14 x 24 x 2 3/8"
 40 units/Bundle



COPING BULLNOSE
 360 x 600 x 60mm
 14 x 24 x 2 3/8"
 40 units/Bundle

Notes: **SOLD IN FULL BUNDLES ONLY** and is produced and sold on a required, refundable skid. Units can be adhered to pool edge using Unilock Concrete Adhesive, or with mortar. Always observe proper construction techniques when adhering pavers to a surface. Consult your local pool contractors for installation specifics.



	SQUARE W/GRILL	SQUARE UNIT	ROUND W/GRILL	ROUND UNIT
Bundle Type	SINGLE	SINGLE	SINGLE	SINGLE
Thickness (mm)	300 MM	300 MM	300 MM	300 MM

DIAMETER (inch)	Outside	56.00	56.00	52.00	52.00
	Inside	40.00	40.00	36.00	36.00
	Insert	38.00	38.00	34.00	34.00

LAYER PER UNIT	3.00	3.00	3.00	3.00
UNIT PER LAYER	16.00	16.00	18.00	18.00
UNIT PER PALLET	48.00	48.00	54.00	54.00

LBS PER PALLET	1,545	1,525	1,145	1,125
-----------------------	-------	-------	-------	-------

COLORS		Stock	Stock	Stock	Stock
Granite	SR. n/a SRI n/a	-	-	✓	✓
Sandstone	SR. n/a SRI n/a	✓	✓	✓	✓
Sierra	SR n/a SRI n/a	✓	✓	✓	✓

APPLICATIONS



APPEARANCE

Edge Detail - Zero
 Surface Texture - Standard
 Joint Spacing - n/a
 Void % - n/a

TECHNOLOGIES

CLASSIC™

Budget-friendly traditional product mix

ANTIQUED™

Distressed, timeworn finish

TECHNICAL INFORMATION

Conforms to ASTM C 1372
 Eligible for LEED v4.1 credits

SUNSET FIRE PIT KIT	Square	Round
Granite	-	RS-CON082
Granite w/Grill	-	RS-CON083
Sandstone	RS-CON037	RS-CON031
Sandstone w/ Grill	RS-CON040	RS-CON034
Sierra	RS-CON036	RS-CON030
Sierra w/ Grill	RS-CON039	RS-CON033

Single Unit				
	SUNSET ROUND W/GRILL 1300 x 1300 x 300mm 51 ¼ x 51 ¼ x 11 ⅞"	SUNSET ROUND UNIT 1300 x 1300 x 300mm 51 ¼ x 51 ¼ x 11 ⅞"	SUNSET SQUARE W/GRILL 1400 x 1400 x 300mm 55 x 55 x 11 ⅞"	SUNSET SQUARE UNIT 1400 x 1400 x 300mm 55 x 55 x 11 ⅞"

Notes: All measurements are nominal. Contact Unilock for more information.

Unilock Elements

Tuscany Collection



TUSCANY FIREPLACE
Sandstone with Copthorne® (3 Color Blend)



TUSCANY FIREPLACE
Sierra with Copthorne® (3 Color Blend)

ELEMENT PRODUCT CODES

<u>Tuscany Collection</u>	Sandstone	Sierra
Fireplace Top	RS-ELE074-1	RS-ELE095-2
Fireplace Bottom	RS-ELE088-1	RS-ELE096-2
Wood box Set	RS-ELE028-1	RS-ELE027-1
Arched Hearth	RS-ELE016-1	RS-ELE017-1

WEIGHTS

<u>Tuscany Collection</u>
Fireplace Top – 2925 lbs
Fireplace Bottom – 4225 lbs
Wood Boxes – 4005 lbs
Arched Hearth – 1170 lbs

Barcelona Collection



BARCELONA FIREPLACE
Sierra with Umbriano® (Summer Wheat)

ELEMENT PRODUCT CODES

<u>Barcelona Collection</u>	Sierra
Fireplace	RS-ELE214
Wood box Set	RS-ELE213
Arched Hearth	RS-ELE212

WEIGHTS:

<u>Barcelona Collection</u>
Fireplace Top – 2725 lbs
Fireplace Bottom – 4170 lbs
Wood Boxes – 4200 lbs
Arched Hearth – 1200 lbs

Unilock Elements

TYPICAL CROSS SECTION FOR CONCRETE PAD INSTALLATION

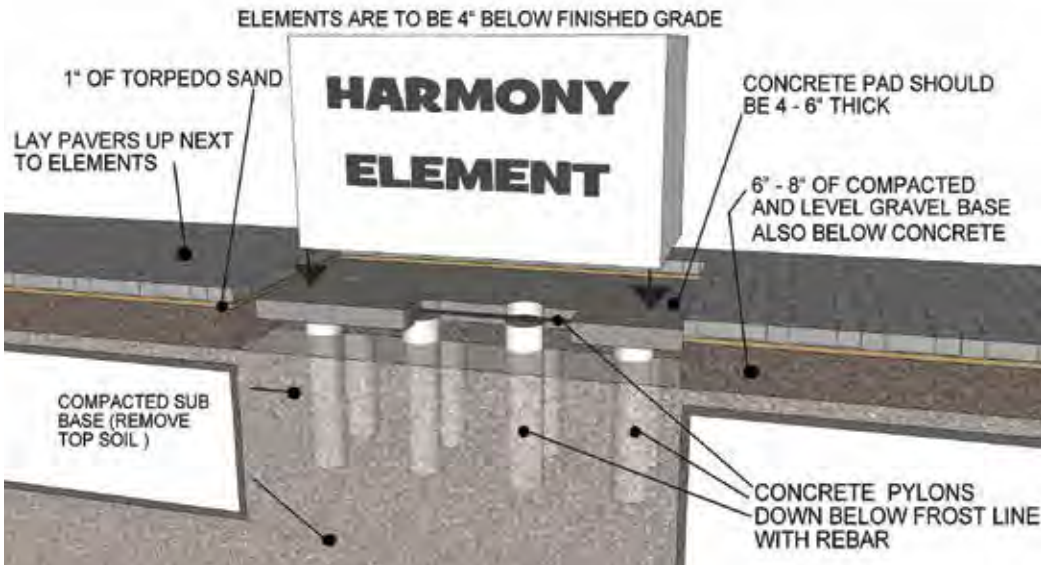

TUSCANY & BARCELONA FIREPLACE

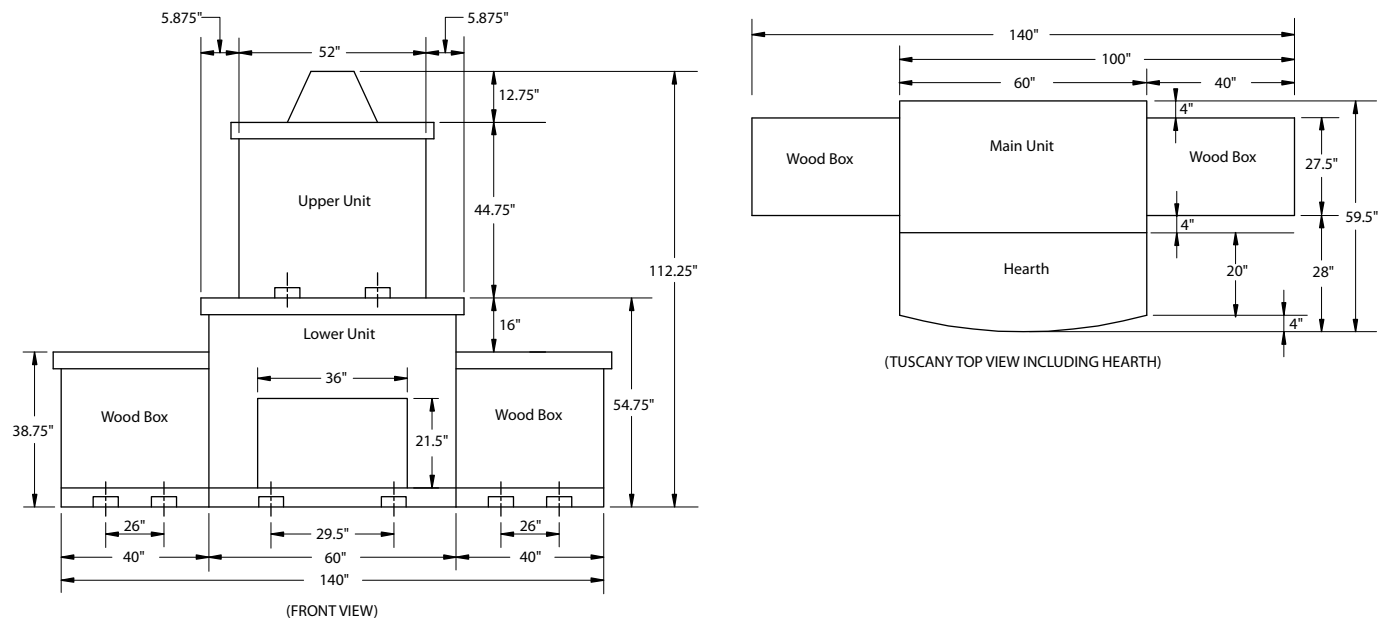

GUARANTEE

The standard Unilock guarantee applies to the units used to construct Unilock Elements. (See Unilock literature for details.) Third party grills and fireboxes carry their respective manufacturer's warranty, and may change without notice.

Note: Unilock reserves the right to change model designs, accessories and colors without notice. Unilock will not be responsible for improper use or handling that results in property damage. Some models may not be exactly as shown. Fireplaces come complete with UL-approved stainless steel fireboxes. Check local building codes and regulations prior to ordering and installing Unilock Elements.

Cleaning Products



- PROFESSIONAL GRADE OIL & GREASE REMOVER**
 RS-CLN001 1 quart; 6/case; 100 cases/skid (600 ea)
- Removes penetrated petroleum-based stains
 - Clean-dries from a liquid to a powder



- PAINT, TAR & RUBBER REMOVER**
 RS-CLN007 1 quart; 6/case; 120 cases/skid (720 ea)
- Effectively dissolves paint, tar, rubber or chewing gum
 - Water-rinsable stones, concrete, and masonry



- PAVER RESTORER**
 RS-CLN044 1 quart; 4/case; 36 cases/skid (144 ea)
- Eco-friendly cleaner removes slurry and polymeric haze
 - Cleans up to 200 sq. ft./gallon



- SUREBOND SURECLEAN**
 RS-CLN014 1 Gallon; 4/case; 36 cases/skid
(27 cases/truckload - HAZMAT)
 RS-CLN063 5 Gallon (SPECIAL ORDER) 36 ea./skid
(25 ea./truckload - HAZMAT)
- Environmentally friendly, non-acid, super concentrated cleaner
 - Dislodges dirt, grime, tire scuffing and environmental soiling
 - Cleans up to 250 sq. ft./gallon
 - 1,000 lbs. HAZMAT weight restriction applies with this product**



- SUREBOND EFFLO OFF**
 RS-CLN062 1 gallon; 4/case; 36 cases/skid
(27 cases/truckload - HAZMAT)
 RS-CLN067 5 gallons (SPECIAL ORDER)
(25 ea/truckload - HAZMAT)
- Heavy-duty, non-acid concentrated cleaner
 - Designed for the removal of efflorescence, mineral and salt deposits
 - Cleans up to 200 sq. ft./gallon
 - 1,000 lbs. HAZMAT weight restriction applies with this product**



- SUREBOND STAIN & RUST BUSTER**
 RS-CLN065 1 quart; 12/case; 36 cases/skid (432 ea)
- Concentrated, environmentally friendly spot cleaner
 - Cleans stains such as moss, mildew, leaf, rust and non-greasy food stains
 - S.R.B. is concentrated; requires dilution prior to use



- SUREBOND SURE STRIP NEW**
 RS-CLN031 1 gallon; 4/case; 36 cases/skid (144 ea)
 RS-CLN032 5 gallons; 36/skid (SPECIAL ORDER)
- Strips away a variety of sealers and coatings
 - Fast-acting, works in minutes
 - Ready to use, no dilution needed
 - Coverage is about 250 Sq. Ft./gallon

Adhesive Products



- SUREBOND SB-10 ADHESIVE**
 RS-ADH009-1 10 oz; 12/case; 140 cases/skid (1680 ea)
 RS-ADH015-1 28 oz; 12/case; 60 cases/skid (720 ea)
- Fast set-up, quick curing
 - Can be applied to wet, damp & frozen block
 - Temperatures ranging from 0 - 100°F
 - 900 psi



- SUREBOND SB-15 ADHESIVE**
*** SPECIAL ORDER - FULL CASES ONLY ***
 RS-ADH050 10 oz tube; 12/case; 140 cases/skid
 RS-ADH051 28 oz tube; 12/case; 60 cases/skid
- Rapid set, 70% faster set time
 - Superior durability including heavy vehicular traffic
 - Temperatures ranging from 10 - 100°F
 - 1200 psi



- ALLIANCE XP GATOR BLOCK ADHESIVE**
 RS-ADH039 10 oz; 12/case; 90 cases/skid (1080 ea)
 RS-ADH040 28 oz; 12/case; 60 cases/skid (720 ea)
- Bonds permanently in 24 hours
 - Material may be repositioned for up to 30 minutes
 - Works in temperatures above 32°F
 - 850 psi in 24 hrs (1000 psi in 7 days)



- TECHNISEAL STRUCTURE BOND™ FOAM ADHESIVE**
 RS-ADH048 24 oz; 12/case; 84 cases/skid (1008 ea)
- Super-strength foam adhesive
 - Most items are bonded in just 8 minutes - Fully cured in 24 hours
 - Works best in temperatures between 0- 120°F
 - Yields up to 600 In.ft. with a 3/8" bead



- TECHNISEAL STRUCTURE BOND™ GUN II**
 RS-TOOL378 1 dispenser gun; 12/case
- Perfect for hard-to-reach applications
 - Limits excessive spillage or dripping
 - Reusable: Easy clean-up using Gun Cleaner



- TECHNISEAL STRUCTURE BOND™ GUN CLEANER**
 RS-CLN093 24 oz/canister; 12 canisters/case
- Rapidly dissolves any uncured Structure Bond adhesive residue



- TECHNISEAL STICKY STONE**
 RS-ADH055 20.3 oz sausage; 15 sausages/case; 66 cases/skid
- Professional-grade vertical hardscape adhesive
 - Perfect for outdoor kitchens, fire pits & columns, etc.
 - Coverage: 1/4" x 1/4" deep area, each sausage will cover 50 linft
 - Applies mess-free and easily with gun applicator



- STICKY STONE GUN**
 RS-TOOL557 1 dispenser gun kit; 10 kits/case
- Heavy-duty dispenser gun specially designed for Stickystone
 - Each gun kit includes: 6 nozzles, 2 extra pistons & steel hook pull

Sealing Products



BACK TO BLACK SEALER

RS-SEAL238 1 quart; 3 quarts/case

- Quickly revives and enhances faded, dark limestone
- Provides stain & water-resistant surface
- 1 Liter covers up to 400 sqft with one coat depending on surface porosity
- LIMITED STOCK AVAILABLE



SUREBOND 8700 WET LOOK JOINT SAND STABILIZER WITH FUNGICIDE

RS-SEAL151 1 gallon; 4/case; 36 cases/skid
(27 cases/truckload - HAZMAT)

RS-SEAL152 5 gallons; 36 ea/skid
(22 ea./truckload - HAZMAT)

RS-SEAL176 55 gallons; 4 drums/skid **SPECIAL ORDER**
(1 drum/truckload - HAZMAT)

- Seals & enhances surface while hardening jointing sand
- Deeply enhances surface with stain-resistant semi-gloss finish
- Formulated with antifungal to stop growth of mold, fungi and moss
- Rain safe in 90 minutes; approx. coverage 80-120 sq.ft.
- **1,000 lbs. HAZMAT weight restriction applies with this product**



SUREBOND 1300 JOINT SAND STABILIZING SEALER

RS-SEAL037-2 1 gallon; 4/case; 36 cases/skid (144 ea)
RS-SEAL036 5 gallon; 36 ea./skid

RS-SEAL038 55 gallons; 4 drums/skid **(SPECIAL ORDER)**

- Stabilizes joints, reduces sand washout, weeds & insects
- Locks in with a clean, natural look & matte finish
- Formulated with antifungal to protect film from mold, moss & algae
- Approximate coverage 80 - 120 sq.ft.



TECHNISEAL® WL4 PROSERIES WET LOOK WATER REPELLANT

RS-SEAL001 1 gallon; 4/case; 45 cases/skid;
(22 cases/truckload - HAZMAT)

RS-SEAL073 5 gallons; 48 ea/skid;
(19 ea./truckload - HAZMAT)

- Solvent-based sealer to enhance pavers with wet-look, high-gloss finish
- Reduces oil & dirt penetration, makes cleaning easier
- Approximate coverage is 150 sq.ft./gallon (750 sq.ft./5 gallons)
- **1,000 lbs HAZMAT weight restrictions applies with this product**

Sand Products continued



SEK POLYSWEEP SAND

RS-SAND045 - Tan | RS-SAND046 - Grey | RS-SAND184 - Black | RS-SAND147 - Platinum | RS-SAND232 - Pearl
50 lb/bag • 56 bags/skid (2860 lbs/skid)

- Recommended for joints up to 3/4"
- Haze Free Guaranteed - Advanced Clear Set Technology
- Coverage 50-75 Sq.Ft./bag with standard 1/4" joints



SEK POLYSWEEP SAND X-TREME WIDE JOINT

RS-SAND111 - Tan | RS-SAND117 - Grey;
RS-SAND185 - Black | RS-SAND149 - Platinum
50 lb/bag • 56 bags/skid (2860 lbs/skid)

- Formulated for joints 1/8" up to 4"
- Haze Free Guaranteed - Advanced Clear Set Technology
- Coverage 50-75 Sq.Ft./bag with standard 1/4" joints



TECHNISEAL SMARTSAND

RS-SAND168 - Prairie Grey | RS-SAND169 - Prairie Tan
50 lb/bag • 56 bags/skid (2860 lbs/skid)
Approx. 100-150sq.ft/gallon coverage

- Haze-free, fast-setting polymeric sand
- Recommended for joints from 1/16" up to 1"
- Minimum Joint Depth is 1.5"
- Coverage: 60-120 Sq.Ft./bag for narrow joints



TECHNISEAL HP NEXTGEL

RS-SAND130 - Prairie Grey | RS-SAND131 - Prairie Tan
50 lb/bag • 56 bags/skid (2860 lbs/skid)

- Dust & haze-free, fast-setting polymeric sand
- Formulated for heavy-sloped, heavy traffic, high humidity and pool decks
- For joints from 1/16" to 4", ideal for joints up to 1"
- Coverage: 60-120 Sq.Ft./bag for narrow joints



ALLIANCE GATOR SUPER SAND

RS-SAND078 - Beige | RS-SAND080 - Slate Grey
50lb bag / 56 bags per skid

- Advanced haze-free polymeric sand
- Formulated for pavers, slabs & wet cast pavers up to 1"
- Rain safe 1 hour after water activation
- Coverage: 65-85 Sq.Ft./bag with joints 1/8" to 3/8"



ALLIANCE SUPER SAND G2

RS-SAND156 - Beige | RS-SAND157 - Slate Grey
50 lb/bag 56 bags/skid

- Intelligent polymeric sand to neutralize haze and dust
- Formulated for joints up to 4" for traditional and up to 2" for overlay applications
- Rapid Set Technology - Rain safe 16 minutes after water activation
- Coverage: 65-85 Sq.Ft./bag with joints 1/8" to 3/8"



ALLIANCE MAXX G2

RS-SAND158 - Beige | RS-SAND159 - Slate Grey |
RS-SAND160 - Black Diamond | RS-SAND161 - Ivory
Packaging: • 50 lb/bag • 56 bags/skid

- Intelligent polymeric sand to neutralize haze and dust
- Formulated for joints up to 4" for traditional applications & up to 2" for overlay applications
- Rapid Set Technology - Rain safe 16minutes after water activation
- Coverage: 65-85 Sq.Ft./bag with joints 1/8" to 3/8"

Sand Products



SEK JOINTING SAND

RS-SAND001-1 - Tan | RS-SAND140 - Grey |
RS-SAND186 - Black | RS-SAND148 - Platinum
50 lb/bag • 56 bags/skid (2860 lbs/skid)

- Recommended for joints up to 3/4"
- Angular jointing sand, washed, screened & kiln-dried
- Coverage: 50=75 Sq. Ft./bag with standard 1/4" joints

Sand Products continued



ALLIANCE EUROSTONE

RS-SAND095 - Slate Grey

- Polymeric sand designed for drainage and non-drainage base systems
- Formulated for joints up to 1.5"
- Works above 32°F
- Coverage 65-85 Sq.Ft./bag with joints 1/8" to 3/8"



ALLIANCE GATOR DUST

RS-SAND072 - Beige | RS-SAND073 - Grey
50 lb/bag • 56 bags/skid

- Polymeric stone dust
- Formulated for joints from 1/2" to 6"
- Ideal with Gator Base application
- Coverage: 20-39 Sq.Ft./bag with joints 1" to 2"



ALLIANCE GATOR NITRO SAND

RS-SAND196 - Beige | SAND197 - Grey / SAND198 - Black
40 lb bucket • 48 buckets/skid

- Ready to use permeable jointing material
- Can be installed in wet or dry weather
- Formulated for joints from 1/2" to 2"
- Ideal for concrete & wetcast pavers, Natural Stone & Porcelain Tile
- Coverage: 10-84 Sq.Ft./bucket depending on joint width

Permeable Chip Products



ALLIANCE GATOR AQUA ROCK

RS-AGG032 - 50lb./bag • 56 bags/skid
RS-AGG033 2200 lb./Super Sack

- Meets ASTM No. 9 requirement for permeable joint units
- High-strength granite ideal for bedding course & jointing material
- Coverage: 20-25 Sq.Ft./bag | 880-1100 Sq.Ft./Super Sack



SEK PERM CHIPS

RS-AGG035 - Eclipse Black | RS-AGG040 - Stormy Grey
RS-AGG037 - Saturn Tan (SPECIAL ORDER/FULL SKID ONLY)
50lb./bag • 56 bags/skid

- 2500 lb Super Sack:
RS-AGG036 - Eclipse Black | RS-AGG039 - Saturn Tan |
RS-AGG041 - Stormy Grey
- High-strength crushed and washed granite meets ASTM No. 9 Stone Specifications for permeable joint filler
 - Ideal for permeable paving stone installations, both as a bedding course and as a joint filler
 - Coverage: 30-35Sq.Ft./bag | 1500-1750 Sq.Ft./Super Sack

Geotextile & Fabric Products

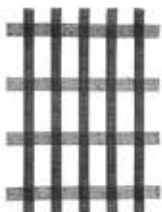

STRATAGRID - SGU60

RS-FAB101

- Geogrid reinforcement for soil and aggregates
- Engineered to be mechanically & chemically durable in harsh construction and aggressive soil environments
- Roll Dimensions: 6.25' wide x 288' length (200 Square Yards)
- 85 lbs/roll

Geotextiles and Fabric Products



UNILOCK DRIVEGRID™ SYSTEM

RS-FAB075

- 120' x 13.1' Roll - 1,572 sq. ft.
- 56 lbs per roll
- **SOLD IN FULL ROLLS ONLY**



GEOTEXTILE FABRIC

RS-FAB001

- 6 oz. Non-woven multipurpose geotextile fabric
- **SOLD IN FULL ROLL QUANTITIES ONLY**
- Roll Dimensions: 15' wide x 300' length (4500 Sq.Ft.)
- 225 lbs/roll



ALLIANCE GATOR GRID 30-30

RS-FAB070 - 4'x50'; 15 rolls/case; 4 cases (60 rolls/skid)
(FULL CASES ONLY)

RS-FAB072 - 6'x150'; 30 rolls/skid

- Biaxial geogrid, with high molecular weight weight and high-tenacity polyester yarns
- High-tenacity polyester yarns woven in tension and finished with PVC coating



GATOR FABRIC GF4.4

RS-FAB044 - 4'x100'; 6 rolls/case; 4 cases (24 rolls/skid)
(FULL CASES ONLY)

RS-FAB047 - 6'x300'; 16 rolls/skid

- Needle punched non-woven geotextile made of polypropylene fibers
- Non-biodegradable and resistant to most soil chemicals

Miscellaneous Items



WALL DRAIN PRO

RS-ACC086 - Black | RS-ACC123 - Grey | RS-ACC122 - Tan
12 units/case; 63 cases/skid (full cases only)

- Simpler, aesthetically pleasing improved water drainage product
- Drain height can be easily modified to use with any block height under 8"



X & T SLAB SPACERS

RS-ACC237 - X Spacers; 2" x 2"; 250 pcs./bag

RS-ACC236 - T Spacers; 2" x 1"; 250pcs./bag

- UniLock recommends using slab spacers when installing Arcana on an open grade surface
- "T" spacers are needed for running bond patterns; "X" spacers for stack bond patterns. Please contact your sales manager for more information.
- X & T bagged separately

Gator Base System

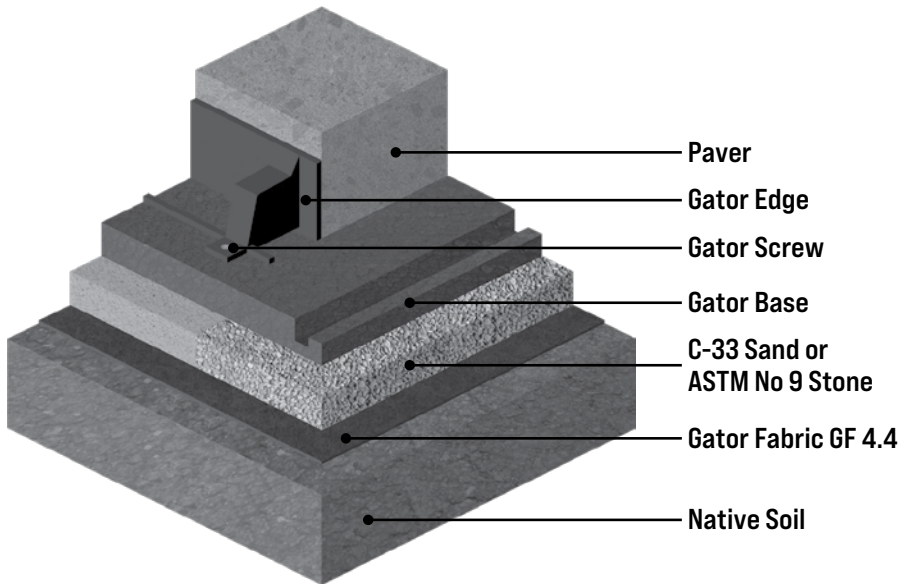

STEP 1 • EXCAVATION FOR THE GATOR BASE INSTALLATION

The total depth required will be determined by adding the thickness of the sand or chip setting bed (3/4" [19 mm]), GATOR BASE (3/4" [19 mm]), and thickness of the paver, slab, stone, or porcelain tile. Excavation depth is approximately 4" for a 2 3/8" [60 mm] concrete paver. Excavate 6" (15 cm) wider than the perimeter of the paved surface or 12" wider (30 cm) when building a seating wall or fire pit.

STEP 2 • LEVELING AND COMPACTING OF THE SOIL

The bottom of the excavated area should be uniform and smooth (+/- 3/8" [10 mm] in 10') and slope in the same direction as the finished paver surface. Compact the soil using a vibrating plate or hand tamper in confined areas.

STEP 3 • ADD GATOR FABRIC GF4.4 AND INSTALL SETTING BED

Cover the bottom and sides of the excavated area with Gator Fabric GF4.4. Spread an even layer of sand (ASTM C33 Concrete Sand) or chip (ASTM No. 9 Stone) in a 3/4" [19 mm] thick layer over the Gator Fabric GF4.4. No compaction is needed for the chip stone. However, the sand-setting bed should be compacted using a hand tamper or vibrating plate. It will help to moisten the sand before compaction. The surface should be smooth, the finished paver surface will mirror the grade set in this step.

STEP 4 • INSTALL THE GATOR BASE

Cover the area with the GATOR BASE panels, 6" (15 cm) wider than the finished paver edge or 12" (30 cm) for a seating wall or fire pit. Lay the GATOR BASE units in an alternating (staggered) pattern - if the Gator Faces line up, the interlocking edges will align perfectly. Gator Base can easily be cut to size using a utility knife.

STEP 5 • INSTALL PAVERS, BLOCKS AND GATOR EDGE

Place the pavers or blocks directly on the GATOR BASE. Adding a 1/2" (13 mm) of bedding sand onto the surface of the GATOR BASE is also an accepted method for non-uniform thickness stone. Install the Gator Edge on the GATOR BASE, firmly against the pavers or blocks. Use a Gator Base Screw every second edging hole to maximize the lateral support provided by the Gator Edge.

STEP 6 • APPLY GATOR MAXX G2 TO PAVER JOINTS

Gator Tile System

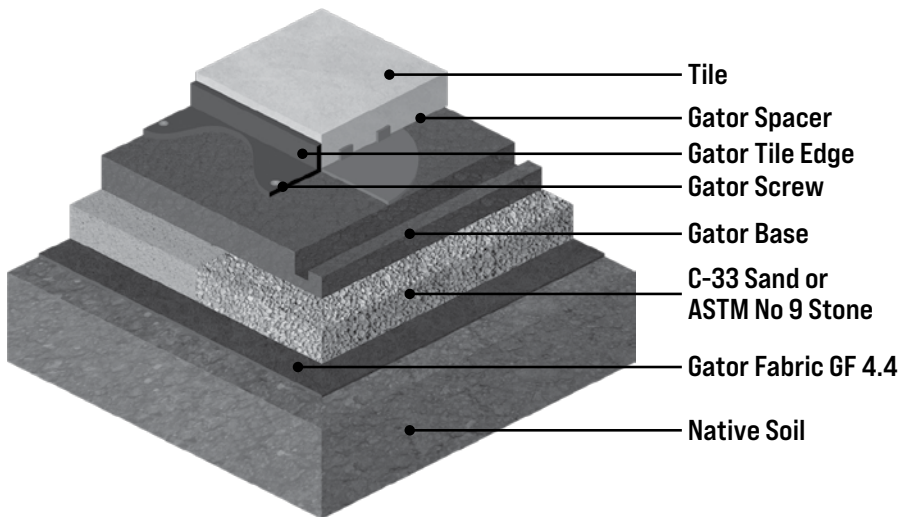

FOLLOW STEPS 1 TO 4 OF GATOR BASE SYSTEM

STEP 5 • INSTALL GATOR SPACER, GATOR XP GLUE AND TILE

The installation of porcelain tile directly on top of the Gator Base using the GATOR SPACER to provide uniform spacing and unparalleled stability. The GATOR SPACER has been designed to provide the right support, load transfer and a monolithic surface binding all units together with the help of the Gator XP Glue on every quadrants of the Gator Spacer.

STEP 6 • INSTALL GATOR TILE EDGE

Install the Gator Tile Edge on the GATOR BASE, firmly against the tiles. Use a Gator Base Screw every second edging hole to maximize the lateral support provided by the Gator Tile Edge.

STEP 7 • APPLY GATOR NITRO TO TILE JOINTS

Gator Base System



Gator Tile System



Edging Products

SEK SNAPEDGE

RS-EDGE001 - 8' (96") piece; 24 pcs./bundle; 28 bundles (672 pcs./skid

RS-EDGE017 - Low Profile; 6' 8" (80") piece; 24 pcs./bundle; 28 bundles (672 pcs./skid

- One-piece edging system that handles both straight & curved installations
- Unique and quick snip 'n flex feature
- Open base design allows root and grass system to grow through
- Standard Sidewall: 1 7/8" | Low Profile Sidewall: 1 3/8"
- Skid Dimensions: 98"L x 48"W x 50"H - 210 lbs./skid

RS-EDGE001

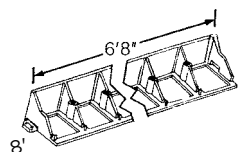

Low Profile - RS-EDGE017



SPIKES

RS-EDGE014 - 10" Round Spike; About 150 spikes/case; 48 cases/skid

- Premium heavy-duty landscape metal spike
- SOLD IN FULL CASES ONLY
- 51 lbs./case; 2,448 lbs./skid



SEK PERMEDGE

RS-EDGE033 - 8' (96") piece; 64 pcs./skid

- Permeable, spikeless edge restraint that includes attached geogrid
- One-piece edging system that handles both straight and curved installations
- Approximate Coverage: 25-30 Ln.Ft./bucket



PERMAEDGE PAVER EDGING

RS-EDGE074 - 5 Gallon bucket; 75 lb./bucket

- Quick & easy to use - cuts install time by 75%
- The perfect combination of strength, flexibility and permeability
- Mix 1 gallon of water to each 5 gallon bucket of PermaEdge
- Approximate Coverage: 25-30 Ln.Ft./bucket



SEK EDGECRETE

RS-EDGE075 - 50lb bag; 56 bags/skid

- Paver restraint in a bag - Just Add Water
- Fiber-reinforced concrete edge restraint
- Simple to install - No spikes needed
- Approximate coverage: - Std. Base - 17 Ln.Ft./bag; Permeable & Open Base- 13 Ln.Ft./bag

Stainless Steel Fireplace Insert

STAINLESS STEEL FIREPLACE INSERT

36" Unit - RS-FIR033; Order with RS-FIR041 (18" Flue Pipe), RS-FIR042 (36" Flue Pipe) & RS-FIR036-1 (Termination Cap)

42" Unit - FS-FIR034; (LIMITED AVAILABILITY); Order with RS-FIR042 (36" Flue Pipe) & RS-FIR036-1 (Termination Cap)

- Outdoor, Wood-burning Fireplace
- Insert comes with refractory panels, mesh spark screen and solid steel log grate
- 254 lbs./Full Kit

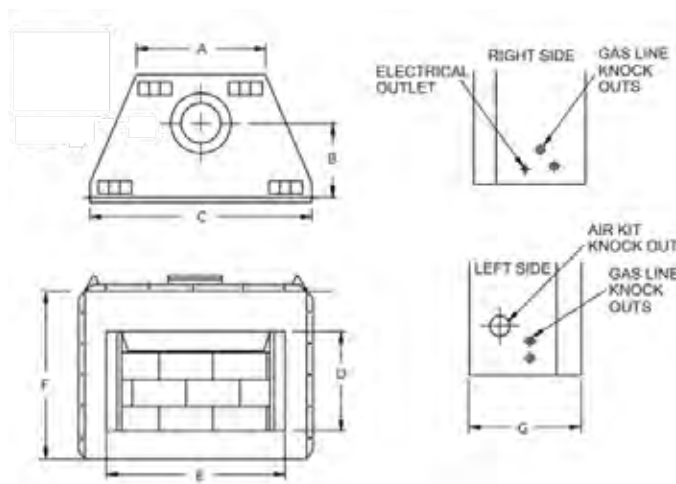

	36	42
A	29"	36"
B	11-3/4"	11-3/4"
C	41"	48"
D	21"	24"
E	35"	42"
F	37"	41"
G	21"	22-1/2"

Unilock Pedestal System

TECHNICAL SPECIFICATIONS

Material	Recycled Polypropylene
Height Range	11/16" - 37-3/8" (17mm to 950mm)
Ultimate Compressive Strength ¹	P Series - 20 kN (4,496 lbs)* T Series - 10 kN (2,360 lbs)* M Series - 15 kN (3,372 lbs)*
Slope correction	0% to 8% @ 1% increment
Base Diameter	P Series - 6.81" (173 mm) T Series - 6.96" (177 mm) M Series - 8.26" (210 mm)
Spacer Tab Height	7/16" (11mm)
Spacer Tab Thickness	3/8" (3mm) [gap between pavers]
Biological / Chemical	Unaffected by molds and algae
Resistance	Good resistance to alkali and bitumen

¹Detailed values for individual heights are given in the technical specification

MAX PEDESTAL ASSEMBLY

ELEMENTS

Gap spacers
Gap spacers create spaces between paver tiles with 3 mm width.

Screw
Units have graduating heights.

Adjustment ring for height regulation
Adjustment ring allows easy and smooth pedestal height adjustment.

Base
Wide pedestal base for better support. Bases have different heights depending on unit.

OPTIONAL ACCESSORIES

Rubber shim
Noise reduction shim. Can also be divided into parts.

Self levelling head
Self levelling head automatically reduces surface slope up to 7%.

Height coupler (use up to 3)
Additional Height couplers can be added to increase pedestal height.

UNILOCK PEDESTAL HEIGHT CHART

T Series are discontinued. Limited quantities available while supplies last. Contact Unilock for more information.

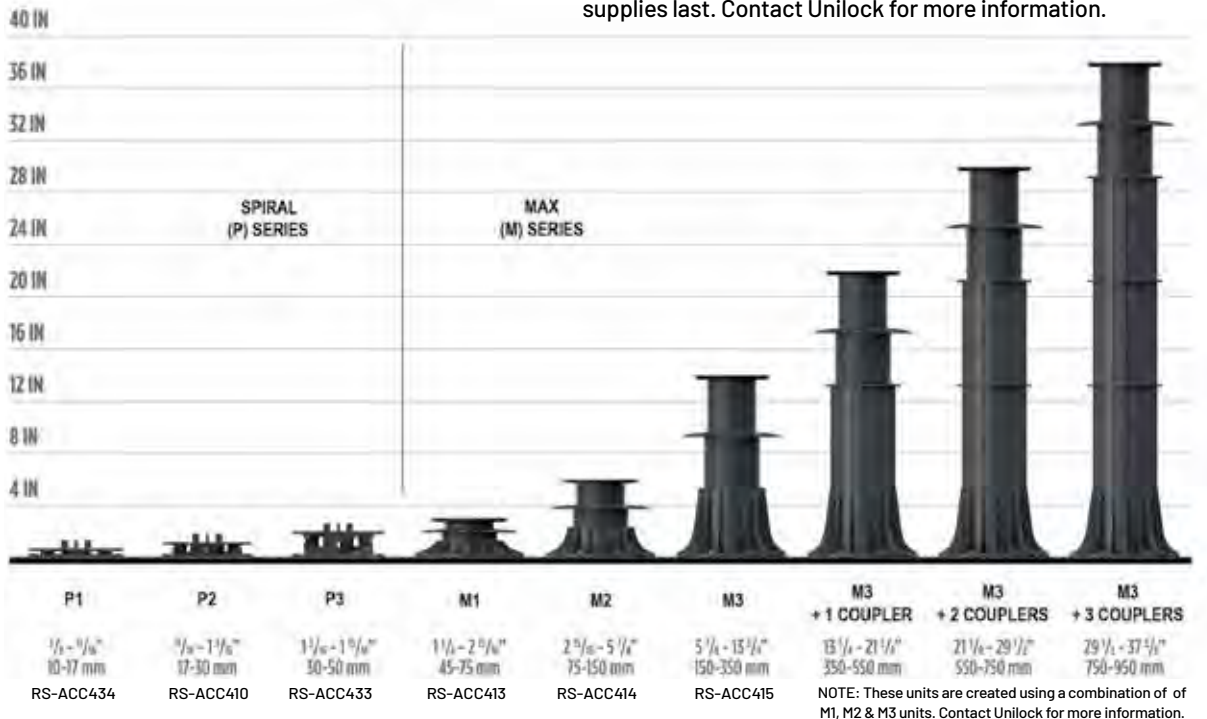

ACCESSORIES

✓ Indicates compatible with Series™, ordered separately. — Indicates not compatible with Series.	Moveable Gap Spacer Tabs 1/8" (3MM)	Self-leveling Head 6% MAX	Rubber Shim 1/16" (1.5MM)	Height Coupler 7/78" (200MM)	Slope Corrector 5/8" (16MM)	Drill Driver	Regulation Key	Wall Edge Clip 1/32" (0.7MM) SPECIAL ORDER
	RS-ACC434	RS-ACC417	RS-ACC421	RS-ACC416	RS-ACC418	RS-ACC422	RS-ACC419	RS-ACC450
SPIRAL (P) SERIES	Gap Spacers Included	✓	✓	—	—	—	—	✓
STANDARD (T) SERIES*	Gap Spacers Included	✓	✓	—	—	✓	—	✓
MAX (M) SERIES*	Gap Spacers Included	✓	✓	✓	✓	✓	✓	✓

Sealer Best Practices

- The paver surface should be **clean** and free from oil, dirt, dust and any loose material. This ensures a uniform result and allows the sealer to better penetrate the surface.
- The pavers should be **free of any visible efflorescence**.
- If pavers have been sealed before, make sure to resealed with compatible product.
- **Surface must be dry** (48 hours without precipitation) and warm to the touch (morning).
- Joint sand must also be dry.
- Make sure lawn sprinklers are shut off.
- Best air temperature is between **50 degrees to 80 degrees** with no rain forecasted for the next 24 hours.
- It is best to apply product under constant weather conditions and use the **same application method from start to finish**.
- The paver joints should be completely filled with dry correctly-graded joint sand. The top level should not exceed the bottom of the chamfer or **1/8" below** the surface on the non-beveled or tumbled paver surface.
- **Always test the product** on a small hidden area to ensure the results will meet your expectations.
- Always show homeowners samples to ensure expectations.

At this point read all sealer instructions and determine the best sealer for your desired goal. Do you want to retain the original look, enhance the color, or stabilize the sand joint?

- **Read application information as each sealer can be applied differently.**
- **Make sure you have the correct equipment based on type of sealer. Solvent based sealers need solvent resistant sprayers, watering cans or paint trays.** Water base sealers can be generally applied using plastic equipment. Example: solvent based sealers come in metal containers and water based sealers come in plastic containers.
- Care should be taken that no excess sealer material is pooled on the surface during application always back roll. When using solvent based sealers make sure roller is solvent resistant or for all paints. Foam rollers work best and are less likely to pull sand from the joints.
- Stabilizing sealers are generally sprayed or flood coated with a watering can, then back rolled.
- Acrylic non-stabilizing sealers can be sprayed, then back rolled or rolled on using a metal paint tray.
- **Send your most experienced worker to do sealing projects.**

Polysand Best Practices

- Ensure that paver surface has **proper drainage runoff** (Min 1" over 8'). Finished paver height should always be higher than grade to allow proper surface drainage.
- **Do not set pavers in limestone screenings.** This product holds moisture and does not meet the gradation, drainage qualities or strength of coarse concrete sand.
- Make sure pavers are **clean of all construction dust**. Residual construction dust will haze pavers!
- **Compact pavers** into setting bed to create proper interlock.
- Read and review all polysand manufacturers methods of application. **(Read Directions)**
- **Don't rush polysand installation.**
- Paver area must be completely dry.
- Lay bags of polysand over paver area. **Stage bags** in areas of coverage. Example: one bag for 60 square feet.
- **Do not over sweep sand.** Sweep sand back and forth within coverage area to fill paver joints.
- Compact sand into joints. This is a must in achieving proper density of the sand joint (repeat 3 times). Compaction is critical to assuring sand strength.
- Do not fill sand above the chamfer of paver. Sand should sit 1/8" below bottom of chamfer.
- Use a fine-bristle broom to **remove any excess sand from the paver surface**.
- Use a **leaf blower** remove any sand or binder residue.
- **Review all watering directions (each manufacturer has different watering instructions.) This is VERY IMPORTANT!**
- Always start watering at the **bottom of the slope**.
- Always start watering in **controlled areas** per manufacturers recommendations. Example: complete watering in 200 sq. ft. area then move on to the next 200 sq. ft. and repeat.
- During final watering of poly sand, **clean surface by removing excess water** with leaf blower or squeegee depending on paver surface texture. This will remove any leftover binder residue or sand.
- Final thoughts - Always be aware of the weather when installing poly sand. **(Temperature and setting time ratings differ between products.)**
- Refer to all manufacturers websites for installation videos.

Terms and Conditions of Sale

STANDARD TERMS

1. All orders are accepted subject to prevailing state or other taxes, and subject to applicable skid charges and the cost of freight applying at the time of shipment. Confirm prices at time of order as they are subject to change.
2. The acceptance by the seller of an order shall constitute a binding contract of purchase and sale, in accordance with the terms set out in this agreement.
3. These terms and conditions, together with the purchase order, form the complete contract, and there are no representations, warranties, or conditions expressed or implied, affecting this contract, other than as contained herein.
4. All sales are made in accordance with the seller's samples, which the purchaser has seen and approved. No guarantee of exact color shades is made.
5. Use of any delivered materials by or on behalf of the purchaser shall be deemed to constitute acceptance of the materials by the purchaser.
6. Excessive defective material picked up or delivered to the purchaser will be replaced free of charge if a claim is made within five days. Free replacement will be the extent of the seller's warranty. Any such claim will not constitute a reason for delaying payment. All other claims must be submitted within 30 days of purchase.
7. Unsuitable or unsatisfactory materials must be available for inspection by the seller to entitle the purchaser to any adjustment or credit. Skid returns will be posted to account next business day.
8. No materials may be returned for credit except with the written consent of the seller, whether such materials were ordered in excess of the purchaser's requirement, by mistake, or otherwise. Where the seller agrees to accept the return of goods, these goods are subject to freight charges and a restocking charge of 20% of their value. All goods must be returned in their original packaging. ACCESSORIES, SECTIONS AND OPENED MATERIAL ARE NONRETURNABLE FOR ANY REASON.
9. Seller does not accept responsibility for delays in deliveries due to fire, flood, strikes, or any other condition or contingencies beyond its control.
10. The purchaser is responsible for installation of the materials on the job site, and the seller has no responsibility in this regard.
11. All approved credit accounts are payable within thirty days of invoice. After 30 days, interest will be charged at 1.5%* per month (A.P.R.19.65%*), Calculated monthly on the balance owing at the beginning of the period. If purchaser defaults in the payment of any portion of amounts due on this account, the entire remaining unpaid balance shall, at the option of the seller, immediately become due and payable with collection costs incurred.
12. Skid deposits are non-refundable with 2 or more broken top boards or one main stringer board. If you have skids loaded onto your vehicle or receive a delivery with skids in this condition, you must have the Unilock representative (loader or truck driver) note the quantity on the shipping document paperwork. The responsibility of the return of empty skids for credit rests with the purchaser. There will be a net usage fee for all skids accepted for return. Skids picked up by Unilock in conjunction with a delivery by a Unilock truck will not be credited until returned to Unilock and sorted and verified by Unilock. Normal delivery charges will apply to requested skid pick-ups which do not coincide with a Unilock delivery to the site.
13. A sectioning charge of \$30.00 is applied to all items where bundles are split.

GENERAL TERMS

1. All prices are F.O.B. Aurora, IL, Marengo, IL or Elkhorn, WI. Please contact Unilock for all freight rates.
2. All C.O.D. orders must be paid by certified check, cash, or prior approved check. Cashier's checks are encouraged over cash due to COVID-19.
3. Contact Unilock for shipping schedules, rates, and conditions, and any fuel surcharges.
4. Configurations may vary from time to time due to mold design changes.
5. Delays incurred on delivery in excess of one hour will be billed to the purchaser at \$80.00 per hour or fraction thereof. Similarly, delays incurred on partial delivery (1-7 bundles) in excess of one half hour will be billed to the purchaser at the same rate.
6. There is a mandatory \$26.00 skid deposit charge for the Standard Four Way Shipping Skids (SKID3842HERM, SKID2640HD & SKID), which are refundable when returned in good condition (a \$2.00 usage fee will be charged). All skid returns will be credited and posted to account the next business day.
7. There is a mandatory \$30 skid deposit charge for the following Wetcast Product Skids (SKIDPREM 1,2,3,4 & 5), which are refundable when returned in good condition (a \$2.00 usage fee will be charged). All skid returns will be credited and posted to account the next business day.
8. There is a mandatory \$34 skid deposit charge for all Canadian/Elegance Skids & Four Way 48" Solid Top Skids (SKIDLTD & SKIDSOLID48), which are refundable when returned in good condition (a \$2.00 usage fee will be charged). All skid returns will be credited and posted to account the next business day.

CUSTOM ORDERS

1. Custom Orders refer to nonstandard-inventoried items. Deposits of up to 100% of the order value (minimum of 20%) will be required. Minimum quantities apply on custom orders. Custom orders may be subject to a [500]sq.ft. over-run charge. Purchase orders as well as a signed special order release form will be required for custom material. Custom Orders will not be accepted for return.
2. All custom produced product must be shipped within 30 days of production. After 30 days all custom produced material will be subject to a storage fee of \$5.00 per pallet per month. Please contact your Territory Manager for more information.

CONFIRM ALL PRICES AS THEY ARE SUBJECT TO CHANGE

2023 Freight Rates

Rates are based on a 0-50 mile radius from Aurora, IL, Marengo, IL & Elkhorn, WI facilities. Please contact the shipping department for all truckload rates and any questions concerning delivery. Approximately 14 bundles or 43,000 pounds per truckload. Delays incurred on delivery in excess of one hour will be billed to the purchaser at \$80 per hour or a fraction thereof. Partial load deliveries in excess of one-half hour will be billed to the purchaser at the same rate. **Fuel surcharge will be added to each order per guide below:**

Cost of Fuel	Flat Surcharge
\$2.30 to \$2.79	\$27.00
\$2.80 to \$3.29	\$42.00
\$3.30 to \$3.79	\$51.00
\$3.80 to \$4.29	\$64.00
\$4.30 to \$4.79	\$78.00
\$4.80 to \$5.29	\$93.00
\$5.30 to \$5.79	\$106.00

Fuel Surcharge for 0-50 miles only

At Least	Less Than	Fuel Surcharge
\$2.30	\$2.79	5%
\$2.80	\$3.29	10%
\$3.30	\$3.79	15%
\$3.80	\$4.29	20%
\$4.30	\$4.79	25%
\$4.80	\$5.29	30%
\$5.30	\$5.79	35%

Fuel Surcharge for deliveries over 50 miles

NOTE: Rates are based on current economic conditions and are subject to fuel surcharges, which will be based on the U.S. National Average Midwest rate of diesel fuel, calculated weekly. When the average price of fuel rises (or drops), the surcharge will take effect the following Monday. These rates can be located at www.eia.gov/petroleum/gasdiesel/.

IMPORTANT NOTES

SPECIAL ORDER PRODUCTS

Products listed as "Special Order" are not currently inventoried and may require additional lead times for manufacturing (or transfer from other Unilock locations). Prior to bidding or quoting projects, confirm Special Order unit pricing and minimum quantity requirements. A signed "Special Order Release Form" must be submitted prior to manufacturing and all material must begin shipping within 30 days of manufacturing date. Any Special Order products remaining at Unilock after 30 days will be subjected to a storage fee of \$5.00 per pallet per month. (Maximum storage is 3 months.) All quantities listed on the Special Order Release Form must ship and be paid in full. Please contact your Territory Manager for more information.

SPECIAL SAND GUIDANCE

EXTRA CARE must be exercised when using Polymeric Sand on the following products:

Arcana Courtstone® Copthorne® Il Campo® Richcliff® Series™ Town Hall® Tribeca Cobble Umbriano™

Polymeric Jointing Sand can be used on these products but the fine polymers and binders in Polymeric Jointing Sand have a natural tendency to adhere to the surface and therefore extra diligence must be taken to pre-clean the surface prior to "wetting the sand in" and squeegee off the surface post application. Failure to do so will result in a "whitish haze" on the surface that is difficult to remove.

IMPORTANT COMPACTION NOTICE: Always pre-compact the pavers WITHOUT SAND IN THE JOINTS. This will facilitate proper leveling. Polymeric sand can then be swept into the joints. Always use a compactor with a protective membrane attached to the bottom of the plate.

Polymeric Jointing Sand, cleaners and sealers, must always be applied by a trained and experienced professional. Contact your local Unilock office for training and the most up-to-date best practices.

NOTICE: Unilock does not accept any responsibility for damage to the surface caused by the improper application and use of polymeric sand, sealers or cleaners. Please refer to each individual manufacturer for full instructions prior to install.

NATURAL STONE INSTALLATION GUIDELINES

A slurry coat, sometimes called a bond or milk sealer coat, is brushed on to the back of each natural stone unit prior to installation in order to limit moisture penetration, prevent staining and aid adhesion.

OPTIMAL COLOR BLENDING INSTALLATION

Blending colors from multiple (3+) bundles is ideal for the optimal color installation. **DO NOT LAY PALLET TO PALLET!**

IMPORTANT NOTES continued

UNILOCK PAVER PATTERNS

This Product Data Guide contains an extensive reference to patterns and designs. The purpose of these pattern swatches is to help the designer plan unique and exceptional designs. The percentages of products shown are based on the pattern and not on bundle configurations. In fact, there may be situations in which a pattern has been created with one particular size of stone, but that stone only comes packaged with two other sizes. This means that the designer will have to plan how the other components are used in the overall plan. This is usually accomplished by adding a border or an accent. As a result, overages or shortages may occur in certain patterns. The designer and/or installer of Unilock products accepts all responsibility for design and all associated costs incurred as a result of applying any of Unilock's suggested design patterns in a project. Please plan your project and review your order carefully prior to ordering.

TRANSFERABLE LIFETIME GUARANTEE

Unilock provides a Transferable Lifetime Guarantee* on the structural integrity of our paving stones, slabs and retaining wall units to the original purchaser of the product for residential use. Any materials installed and maintained to our guidelines, and subject to normal wear, that prove defective, will be replaced without cost. Color matching cannot be guaranteed and replacement labor is not included. Proof of purchase is required.

Excessive defective material (over the industry accepted normal of 2% for non-tumbled unit pavers) delivered to the purchaser will be replaced free of charge if a written claim is made within 5 days of delivery from the manufacturer. Such claims will not constitute reason for delaying payment. All goods shall be deemed accepted if completely installed. Inspect concrete products prior to opening bundle packaging to ensure that shape and color are as ordered. Unsatisfactory material must be available for inspection by Unilock to entitle the purchaser to any adjustment or credit. Inspect all concrete units during installation and set aside any which are chipped or cracked to use for any cut pieces required. The color of concrete products may vary significantly between production lots. Always install concrete units from several bundles simultaneously to ensure proper distribution of color. Prior to final compaction, inspect installed pavers for good color distribution. Relocate certain pavers, if necessary, to achieve desired color blend.

*Transferable Lifetime Guarantee: Register your project within 60 days of your dated proof of purchase to ensure your Unilock Guarantee is fully transferable! Simply go online at unilock.com and follow instructions. Once processed, you will receive an original Transferable Warranty Certificate for your records.

PRODUCT HANDLING WARNING

Bundle Straps Under Tension - Use extreme caution when removing or handling straps. Always wear gloves, goggles, safety footwear, and protective clothing when removing or handling straps. Failure to do so may result in serious bodily injury or loss of sight.

Cut all concrete products only in well ventilated areas. Inhalation of dust is a serious health risk. A "NIOSH" (US) or a "CSA" (CDN) approved respirator, safety goggles, hearing protectors, and gloves must be worn at all times. Always "wet-cut" or "wet grind" concrete products to minimize dust.

Do not stack bundled concrete products higher than 2 bundles high. Contents of the bundle may be unstable and subject to topple when stacked. Always use extreme caution and appropriate equipment when transporting or storing bundled concrete products. Failure to do so may result in serious bodily injury or death. Always obey gross vehicle weight (GVW) loading limitations and regulations.

Hazard Rating: Fire 0, Health 1, Reactivity 0. See MSDS Concrete Masonry (Pavers). Contact Unilock for complete sheet or view safety information at Unilock.com.

Unilock assumes no liability or responsibility for loss or damage, resulting from the improper use or handling of our products, or from failure to follow instructions, warnings, and/or advisories on the product label, and on the MSDS sheet.

TRADEMARK & LEGAL INFORMATION

Umbriano® is a trademark of Metten Stein + Design GmbH & Co KG used under license by Unilock. Unilock Ltd. and Hengestone Holdings, Inc. are the owners or authorized users of all trademarks used in this publication unless otherwise specified.

Colors shown in this brochure should be used only as a guide. Colors should always be chosen from actual samples. Contact your local Unilock representative for color availability in your area. Not all products shown are available at all Unilock locations. Log on to www.unilock.com for availability. Measurements throughout this portfolio are nominal.

©2023 Hengestone Holdings, Inc.



QUALITY COMMITMENT

Unilock was the first concrete paver manufacturer in North America to offer a Lifetime Guarantee, and since then we have continued to stand behind it to ensure customers are completely satisfied with our products. With almost 2 billion stones in the ground, that's quite the commitment!

Our products are better and stronger than other brands. In fact, our internal standards of manufacturing in the USA and Canada far exceed industry standards set by ASTM (American Society for Testing and Materials) and CSA (Canadian Standards Association) and other European organizations.



LIFETIME GUARANTEE - RESIDENTIAL

Our Transferable Lifetime Guarantee warranties the structural integrity of Unilock concrete paving stones and retaining wall units when used in residential applications. It covers any structural failure or deterioration of the concrete unit resulting from normal use or from the reasonable application of sodium chloride (common rock salt used for de-icing). StoneMark™ products have the same warranties as Unilock paving stones and retaining walls, but cannot be warranted against damage resulting from de-icing products.

Any materials installed and maintained to our guidelines, and subject to normal wear, that prove defective, will be replaced without cost. Proof of purchase is required. Customers are encouraged to submit receipts to us as soon as their project is complete, using the Unilock Warranty Registration Form on our website (Unilock.com).

Purchasers need to ensure that the product they purchase is appropriate for their intended application; for example, only certain thicknesses of products are appropriate for driveways. Color matching of the replacement product and/or lost time cannot be guaranteed and labor costs related to installing replacement product is not included. Unilock reserves the right to seek a professional diagnosis and opinion to determine the exact cause of the product failure. If the failure falls within our warranty parameters, Unilock will replace the defective product.

EXCLUSIONS - Unfortunately, some things are beyond the control of Unilock, and are therefore not covered by this warranty. These include: naturally occurring efflorescence, hazing from polymeric jointing sand, scratching and chipping resulting from snow removal or construction equipment, damage caused by natural or un-natural disasters, or negligence by anyone other than Unilock. While EasyClean helps to increase a paver's resistance to staining from various substances, it does not make our products stain-proof nor does it resist every kind of stain. The Unilock warranty also does not cover deterioration or damage as a result of

poor design or poor installation practices that are contrary to specifications as laid out by ICPI (Interlocking Concrete Pavement Institute) and the NCMA (National Concrete Masonry Association). For more information please visit www.icpi.org and www.ncma.org. Additionally, please refer to the Maintenance, Color and Installation Advisories.

MAINTENANCE ADVISORY

1. Cleaning and Sealing

As with anything that is outdoors, Unilock products are subject to harsh weather, dust, acid rain, leaf stains, water stains and general wear from foot or vehicular traffic. Therefore, periodic cleaning using environmentally safe detergents designed for cleaning concrete is recommended to maintain a bright, fresh appearance.

To make subsequent cleaning easier and more effective, a concrete sealer can be applied to new or cleaned products to help prevent the penetration of substances that can cause stains.

There are many types of concrete cleaners and sealers on the market. Always read the instructions carefully before using the product to make sure that it will function as expected. Testing first, in a small unobtrusive area, is always a good idea to ensure the results are acceptable. Consult your local hardscape dealer to find the products best suited for your paver or wall installation.



Visit Unilock.com to register for your Transferable Lifetime Guarantee.

2. Winter Maintenance

Snow removal by way of metal blades on plows or shovels will scratch and chip the surface of pavers, causing permanent damage. To mitigate this risk, metal snow clearing blades must always have a polyurethane or rubber cutting edge attached when plowing pavers.

De-icing Salts - The use of de-icing products on paver surfaces is important for safety and to help mitigate snow accumulation. Most de-icing products will have some effect on concrete, even if the product label indicates that it is safe on concrete. If you must use a de-icing product, we recommend that you use Sodium Chloride (ordinary rock salt) or Calcium Chloride (for colder climates). Always apply sparingly. The use of de-icing products on StoneMark, wet-cast pavers, slabs or coping may damage the product and therefore is not recommended. Whenever possible use a coarse sand as an anti-slip measure instead of de-icing chemicals.

COLOR ADVISORY

1. Selection

Due to the inherently variable nature of printed materials and digital monitors, Unilock cannot guarantee that products will match the color of printed or online images. Therefore, when making final product selections, decisions should be made based on actual stones which are readily available from Unilock, Authorized Contractors or Authorized Dealers. Most Unilock products are not comprised of a single color, but rather contain blended colors for a more natural appearance. This means that there will be significant color variance from stone to stone, so purchasers should view multiple units together to get a more accurate impression of the overall color.

Note: Unilock Natural Stone variations are outside the control of Unilock.

Purchasers of natural stone must be willing to accept this inherent variability.

2. Pre-installation checking

Always check the label to ensure that the Unilock product delivered to your project is the product and color ordered. If there is a discrepancy, or if the product inside the packaging doesn't appear to be correct, contact your hardscape dealer before installing any pavers or wall units. If the product is installed, it indicates your acceptance of the products as delivered.

3. Blending

If the project requires more than one bundle of product it's always a good idea to draw product from several bundles when installing, as this ensures that any variation between bundles will be seamlessly integrated in the project. When bundles are from different production runs, random selection from multiple bundles is even more important.

4. Efflorescence

Efflorescence is a naturally occurring process that may appear as a white or light grey powder on the surface of concrete, clay or natural stone. It is temporary, and will disappear over time. However, if it is bothersome, an efflorescence cleaner can be used to remove it. There is no way to predict or prevent efflorescence. Because it does not compromise the structural integrity of the product, it is not covered by Unilock product warranties.

INSTALLATION ADVISORY

1. Construction Residue

While a certain amount of dirt on pavers and walls is inevitable during the construction phase, installers are strongly encouraged to clean as they go as construction residue can embed in the surface and become difficult to remove. The slurry produced during wet-saw cutting is particularly stubborn to clean if allowed to dry on the surface of pavers. Unilock warranties do not cover stains caused by a failure to remove construction residue.

2. Polymeric Haze

Surface hazing caused by polymeric jointing sand is not the responsibility of Unilock. Polymeric jointing sand should only be installed by an experienced and knowledgeable contractor. Any sand that is left on the surface prior to activation will result in a haze that is very difficult and time-consuming to remove. Only the highest quality, brand name polymeric sand that is guaranteed by the manufacturer should be used.

3. Compaction Damage

Both smooth and textured paver surfaces can be scratched by compaction equipment used to 'flatten' a new paver installation. Therefore, metal plate compactors must be fitted with a polyethylene mat to protect the paver surface from becoming scratched, or a superior option is to use a rubber-roller compactor instead. Damage to product surfaces caused by failure to follow these instructions is not covered by Unilock product warranties.

FIRE PIT WARNING

Wood-burning fire pits must be lined with a proper metal insert or refractory (fire-rated) brick to protect the concrete components from extreme exposure to heat. Extreme heat on a concrete surface may affect the structural integrity of the concrete and can be dangerous. The floor of the fire pit should always be constructed using refractory brick or a sand bed. For your safety, always use a spark screen over the fire.

CHICAGO PRODUCT DIRECTORY

UNIT PAVERS

Product	Page	Finish	Pedestrian	Residential Vehicular	Commercial Vehicular	Environmental	For Borders & Accents
ADA Paver	4	S	✓				
Anchorlock™	5	S	✓		✓		
Arcana™	6	SM	✓				
Artline™	7	M	✓	✓			
Beacon Hill™ Flagstone	10	F	✓				
Beacon Hill™ Smooth	12	SM	✓				
Bristol Valley®	14	F	✓				
Brussels Block®	16	W	✓	✓			✓
Cophthorne®	17	T	✓	✓			✓
Courtstone®	18	C	✓	✓			✓
Eco-Line®	19	M	✓	✓	✓	✓	✓
Eco-Optiloc™	20	M	✓	✓	✓	✓	
Eco-Priora™	21	M	✓	✓	✓	✓	
Eco-Promenade®	22	M	✓	✓	✓	✓	
Hex Paver™	23	S	✓	✓			
Hollandstone™	24	S	✓	✓	✓		✓
Holland Premier™	26	S	✓	✓			✓
Mattoni™	27	SM	✓	✓			✓
Natural Stone	28	SM	✓				
Nordic Cobble™	32	WS	✓	✓	✓		✓
Optiloc®	33	M	✓	✓	✓		
Porcelain	34	SM	✓				
Promenade® Paver	37	M	✓	✓	✓		✓
Richcliff®	39	T	✓	✓			✓
Series™	40	WS	✓	✓	✓		✓
Skyline™	42	S	✓				
Soreno™	43	SM	✓				
Town Hall®	44	T	✓	✓	✓	✓	✓
Treo® Smooth	45	SM	✓	✓		✓	✓
Tribeca Cobble	46	WS	✓	✓	✓	✓	✓
Turfstone™	47	S		✓	✓	✓	
Umbriano™	48	SZ	✓	✓	✓	✓	✓
Westport™	50	T	✓	✓			✓

RETAINING WALLS

Product	Page	Finish	Gardens	Retaining Walls	Steps	Seatwalls	Pillars
Brussels Dimensional Stone®	51	W	✓		✓	✓	✓
DuraHold®	52	SM		✓	✓	✓	
Estate Wall™	53	SP/W	✓	✓	✓	✓	✓
Lineo™ Dimensional Stone	54	SM	✓		✓	✓	✓
Olde Quarry™	55	W	✓	✓	✓	✓	✓
Olde Quarry™ Smooth NEW	56	SM	✓	✓	✓	✓	✓
Pisa™	57	SP	✓	✓	✓	✓	✓
Pisa™ Smooth NEW	58	SM	✓	✓	✓	✓	✓
SienaEdge™	59	SM		✓	✓		
SienaStone®	60	SP		✓	✓		
U-Cara®	62	M	✓	✓	✓	✓	✓

Finishes: B=Brushed; C=Cobblestone; F=Flagstone; M=Multiple Finishes; S=Standard; SM=Smooth; SZ=Smooth Zero Bevel; SP=Split; SP/W=Split and Weathered; T=Timeworn; W=Weathered; WS=Washed

This application chart should only be used as a guide. Site conditions, base materials, pattern and frequency of use may vary the performance of various types and styles of products.

J-CARA®

THE MOST COMPLETE HARDSCAPE WALL SYSTEM

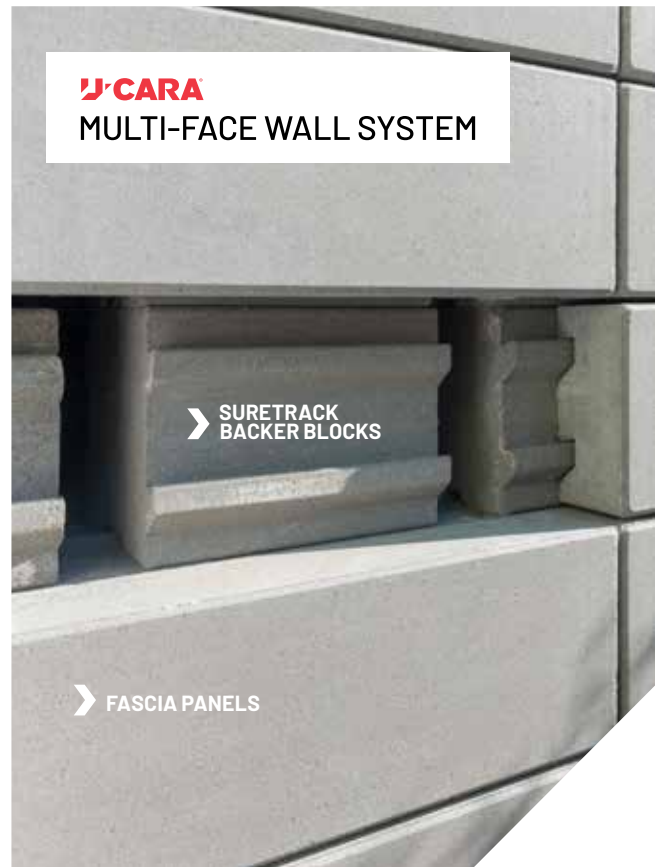

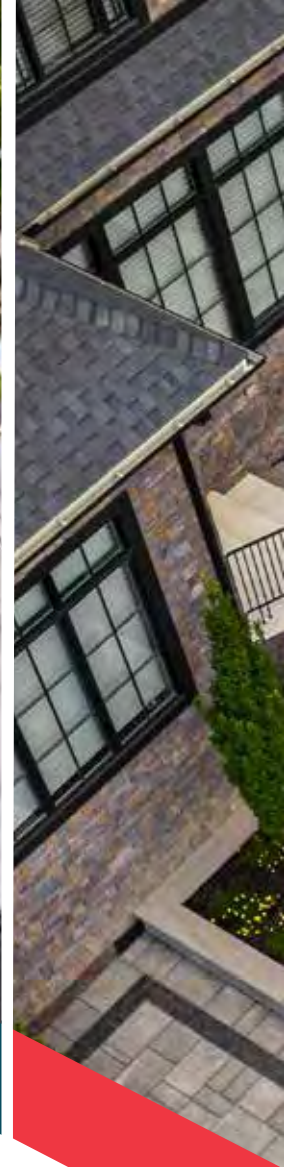

Let's **BUILD YOUR BUSINESS** together.

**CONTACT 1-800-UNILOCK OR VISIT UNILOCK.COM TO
CONNECT WITH YOUR LOCAL TERRITORY MANAGER**

BOSTON
(508) 278-4536

CHICAGO
(630) 892-9191

MILWAUKEE
(262) 742-3890

KANSAS
(913) 417-7985

MICHIGAN
(248) 437-7037

NEW YORK
(845) 278-6700

MID-ATLANTIC
(202) 798-2060

ONTARIO
(416) 646-9000

CINCINNATI/KY/TN
(513) 202-0219

**OHIO/WESTERN PA/
WNY&CNY**
(330) 927-4000

UNILOCK.COM | 1-800-UNILOCK

©2023 Hengestone Holdings, Inc.